

A close-up, grayscale photograph of a car seat's headrest and backrest. The upholstery has a fine, pebbled texture, characteristic of leather or a high-quality synthetic material. The lighting creates soft shadows and highlights, emphasizing the contours and texture of the seat.

logiflex

**SOFTSEATING
PRICE LIST**

USA

Table of Content

Terms and conditions			1
Warranty			1
Production specifications			1
Armchair Section			
General characteristics			3
Alpha	1403	Armchair 1 place	4 - 5
	1405	Armchair 2 places	4 - 5
	1407	Armchair 3 places	4 - 5
Bulexi	5010	Armchair	6 - 7
	5020	Love seat	6 - 7
	5030	Sofa	6 - 7
Flint	3010	Armchair	8 - 9
	3020	Love seat	8 - 9
	3030	Sofa	8 - 9
Kalypso	2010	Armchair	10 - 11
	2020	Love seat	10 - 11
	2030	Sofa	10 - 11
Monro	4010	Armchair	12 - 13
	4020	Love seat	12 - 13
Robi	1010	Armchair	14 - 15
	1020	Love seat	14 - 15
Sedia	803	Chair	16 - 17
	804	Chair	16 - 17
	805	Chair	16 - 17
Stelli	6750PM	Armchair	18 - 19
	6753PM	Love seat	18 - 19
	6757PM	Sofa	18 - 19
	6755SPM	Square Ottoman	20 - 21
	6755TPM	Rectangular Ottoman	20 - 21
	6759	Mobile soft seat with back handle	20 - 21
Tobi	1050	Armchair	22 - 23
	1060	Love seat	22 - 23
Modular Section			
Introduction to the Infiniti series			25
Infiniti	010	Square bench	26 - 27
	020	Arched bench	26 - 27
	030	Oval bench	26 - 27
	040	Combination of square bench with padded arm	28 - 29
	045	Combination of square bench with padded arm and melamine	28 - 29
	050	Combination of square bench with curved arm	28 - 29
	055	Combination of square bench with curved back	28 - 29
	SUA	padded arm	30 - 31
	SUAM	padded arm with melamine	30 - 31
	CA	Curved arm	30 - 31
	CB	Curved back	30 - 31
Table Section			
Auxiliary Tables	MANHATTAN		33
	FLINT		34
	KALYPSO		35

Important

This price list may be subject to changes without prior notification.

Terms and conditions

Price

All prices included within this document are suggested retail prices.

Terms

Net 30 days from date of invoice for customers with an established credit. An amount of 2% interest per month will be applied on all overdue account after 30 days. Merchandise will be invoiced at the time of shipment. All accounts are C.O.D. unless credit has been established. No shipment will be made to past due accounts. Accounts with outstanding balances due to returned checks or past due accounts placed for collection will not be shipped merchandise until all balances and charges are paid in full.

Returns

No returns will be accepted without prior written authorization. Returns are subject to a minimum of 25% restocking and handling charge which will be deducted from credit. The freight must be prepaid by the customer.

Cancellation

Orders in production cannot be cancelled unless written approval is received from **Logiflex**. A minimum cancellation charge of 25% is applicable in all cases.

Modification

All modifications on new orders need to be done no later than 48 hours of receiving it.

Freight & delivery

All prices contained herein are suggested retail prices - FOB factory, Sherbrooke, Quebec, Canada. Any and all freight conditions or arrangements other than above must be authorized in writing by **Logiflex** and will be limited to conditions agreed upon. Deliveries to be forwarded to the dealer / distributor store or warehouse only.

Shipments with requested delivery other than above subject to an extra fee as charged by the carrier. Any delay at your docking facility could also call for an extra fee for which you could be requested to pay directly to the carrier.

Warranty

Logiflex guarantees all its products against all manufacturing defects, under normal conditions, for a period of five (5) years. This warranty applies only to the original owner of the product and must have been purchased from an authorized **Logiflex** distributor.

The warranty does not apply to claims resulting from the following:

- normal wear;
- modification, transformation, repair or renovation not authorized by **Logiflex**;
- renting to third party;
- normal defects in leather such as;
 - scars, marks
 - difference in stain within a leather skin or between different skins.

This warranty covers repair or replacement, it does not cover the cost of transportation.

Production specifications

The COM fabrics are based on 1st price range. A sample of COM fabric must be sent to **Logiflex** for approbation before the order can be accepted. COM fabrics are used at the client's risk and are not covered by the Logiflex warranty. COM fabrics must be delivered to our factory, shipping, custom duties and brokerage fees "prepaid" with the following information provided: fabric description, number of yards delivered, order number, client name. If the fabric is delivered directly from the manufacturer **Logiflex** reserves the right to refuse any fabric that does not comply with the informations mentioned above.

Leather specifications

All leathers used are "Cowhide".

Please note that the warranty does not apply on leather's natural imperfections, such as: scars, marks, and difference in stain within a leather skin or different skins. This specification also applies for standard leather GR5 and Italian leather GR6.

**A
R
M
C
H
A
I
R**

**S
E
C
T
I
O
N**

General Characteristics

Fabric

In order to improve our service, we suggest the use of our main supplier's websites to discover all of their fabric collection. Consequently, we will be pleased to quote a price for the chosen fabrics available.

Available suppliers:

J-Ennis	http://www.jennisfabrics.com/web/index
Momentum	https://www.themomgroup.com/
Victor	http://www.victor-innovatex.com/en/
Maharam	http://www.maharam.com/
Triden	http://www.triden.com/

Wood color

All wooden items offered in this price list are stained using the Logiflex wood finish melamine color. Refer to our current color chart.

Polyurethane foam

The Velva branded polyurethane foam used for the fabrication of our armchairs is anti-bacterial. Different densities exist and will vary from one armchair model to the other. Medium density foam is employed for back and seating parts, while the firmer density foam is used for armrest parts.

Top stitchings

Different top stitchings are available for different armchair models.

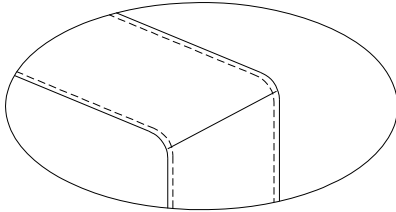

Simple top stitching

Available for armchair: **Monro**, p.12
Stelli, p.18
Ottomans Stelli, p.20

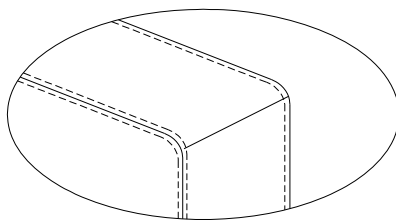

Double top stitching

Available for armchair: **Flint**, p.8
Monro, p.12
Sedia, p.16
Stelli, p.18
Ottomans Stelli, p.20

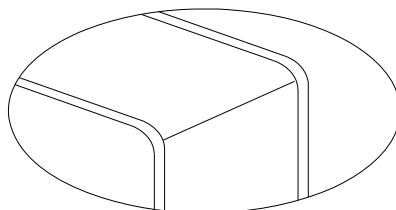

Decorative piping

Available for armchair: **Bulexi**, p.6
Flint, p.8
Sedia, p.16
Tobi, p.22

How to order?

1403

Fabric: Rockwell/Sand #8003, GR2

Fabric name Fabric color Range

ALPHA

** The VELVA polyurethane foam used meets the standard norms: **
anti-bacterial and California 117 (fire resistant).

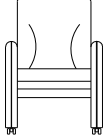
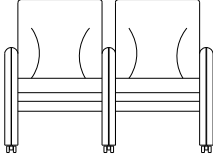
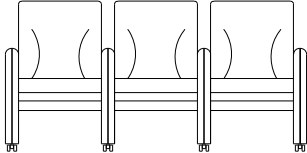
MODELS	DESCRIPTION	RETAIL PRICE					
		GR1	GR2	GR3	GR4	GR5	GR6
Armchair #1403 	Standard armchair components: - 4 wheels; - Simple top stitching; - Medium density Velva foam on seat; - 1" Memory foam on back; - Molded wood boards for seat and back; - Rest of frame made out of recycled particles.	888	981	1091	1201	1656	1829
* Fabric combinations: use highest price range.							
Armchair 2 places #1405 	Standard two places components: - 6 wheels; - Simple top stitching; - Medium density Velva foam on seat; - 1" Memory foam on back seat; - Molded wood boards for seat and back; - Rest of frame made out of recycled particles.	1373	1510	1675	1840	2407	2638
* Fabric combinations: use highest price range.							
Armchair 3 places 1407 	Standard three places components: - 8 wheels; - Simple top stitching; - Medium density Velva foam on seat; - 1" Memory foam on back seat; - Molded wood boards for seat and back; - Rest of frame made out of recycled particles.	1737	1902	2122	2342	3042	3388
* Fabric combinations: use highest price range.							

OPTIONS



Levelers 7/8" diameter.

N N/C



Hard surface wheels.

HF N/C

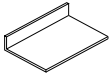

Fixed wood shelf 3/4" thick installed under the seat.
(Choice of wood finish melamine color)

FS 151

** Include the options at the end of the code Ex.: 1403NFS.
Armchair with levelers and fixed wood shelf.

** Selection of foam density available (price available upon request only).

Please note that the warranty does not apply on leather's natural imperfections, such as: scars, marks, and difference in stain within a leather skin or different skins. This specification also applies for standard leather GR5 and Italian leather GR6.

MODELS

Armchair #1403

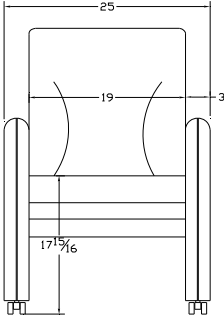

Love seat #1405

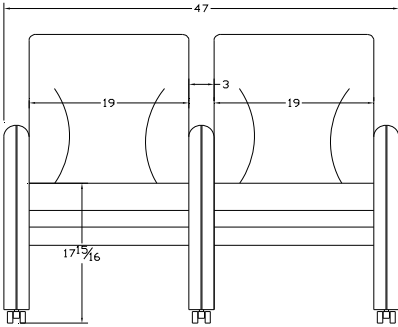

Sofa #1407

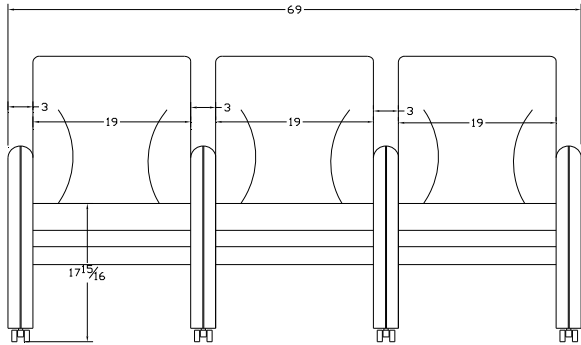

C.O.M. fabric :

It is possible to order these armchairs with the client's fabric, please follow these instructions:

1. Fabric prices are based on 1st price range of each model.

2. Choose the number of yards desired, specific to the chosen model, to be ordered to the supplier.
COM fabrics must be delivered to our factory, shipping, custom duties and brokerage fees "prepaid" with the following information provided: fabric description, number of yards delivered, order number and client name. A late reception of fabric may cause delivery delays.

	1403	1405	1407
	888	1373	1737
	5 yds	7 yds	11 yds

How to order?

5010BWL

Fabric: Rockwell/Sand #8003, GR2, Base: Whisky
 Fabric name Fabric color Range Base color

BULEXI

** The VELVA polyurethane foam used meets the standard norms: **
 anti-bacterial and California 117 (fire resistant).

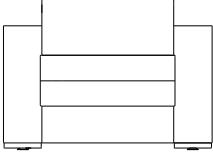
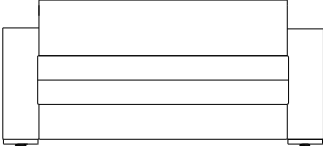
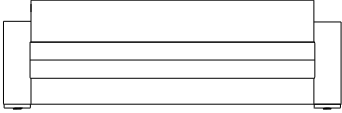
MODÈLES	DESCRIPTION	Retail Price					
		GR1	GR2	GR3	GR4	GR5	GR6
Armchair #5010BWL 	Standard armchair components: - 4 wooden legs BWL (Choice of Logiflex wood finish melamine color); - Double top stitching; - Elastic straps on back; - 9 GA springs within the seat; - Medium density Velva foam on the seat; - Medium density Velva foam with 1" of foam memory for the back; - All cushions are covered with stitched Dacron; - Back seat cushions are fixed to the structure by a zipper; - Made out of recycled particles, seating and back structure made of hardwood and plywood.	1494	1615	1752	1890	2349	2580
* Fabric combinations: use highest price range.							
Love seat #5020BWL 	Standard love seat components: - 4 wooden legs BWL (Choice of Logiflex wood finish melamine color); - Double top stitching; - Elastic straps on back; - 9 GA springs within the seat; - Medium density Velva foam on the seat; - Medium density Velva foam with 1" of foam memory for the back; - All cushions are covered with stitched Dacron; - Back seat cushions are fixed to the structure by a zipper; - Made out of recycled particles, seating and back structure made of hardwood and plywood.	2060	2225	2445	2665	3042	3388
* Fabric combinations: use highest price range.							
Sofa #5030BWL 	Standard Sofa components: - 4 wooden legs BWL (Choice of Logiflex wood finish melamine color); - Double top stitching; - Elastic strap on back seat; - 9 GA springs within the seat; - Medium density Velva foam on the seat; - Medium density Velva foam with 1" of foam memory for the back; - All cushions are covered of stitched Dacron; - Back seat cushions are fixed to the structure by a zipper; - Made out of recycled particles, foundation and back structure made of hard wood and plywood.	2580	2778	3014	3251	4081	4543
* Fabric combinations: use highest price range.							

OPTIONS



4 chrome metal legs (sold by packages of 4 only).

BCHR 336 / set of 4

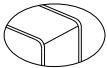

Decorative piping

CPG N/C

** Replace the BWL for wooden legs, if necessary and include **
 the options at the end of the code Ex.: 5010BCHRCPG.
 Armchair with 4 chrome metal legs and decorative piping.

** Selection of foam density available (price available upon request only).

Price upon request for dimension modifications, in length only for armchairs, love seats or sofas.

Please note that the warranty does not apply
 on leather's natural imperfections, such as: scars, marks,
 and difference in stain within a leather skin or different skins.
 This specification also applies for standard leather GR5
 and Italian leather GR6.

MODELS **Retail Price**

Armchair #5010BWL

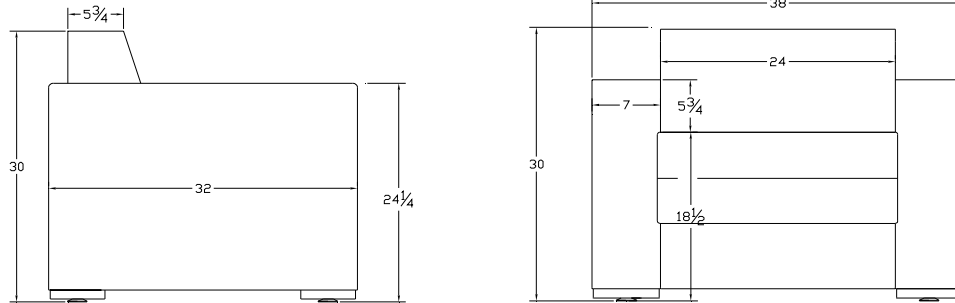

Love seat #5020BWL

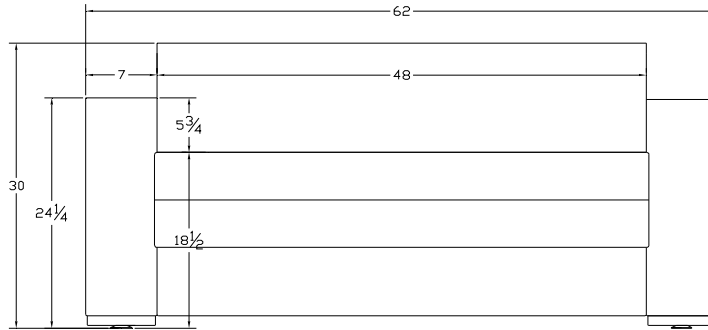

Sofa #5030BWL

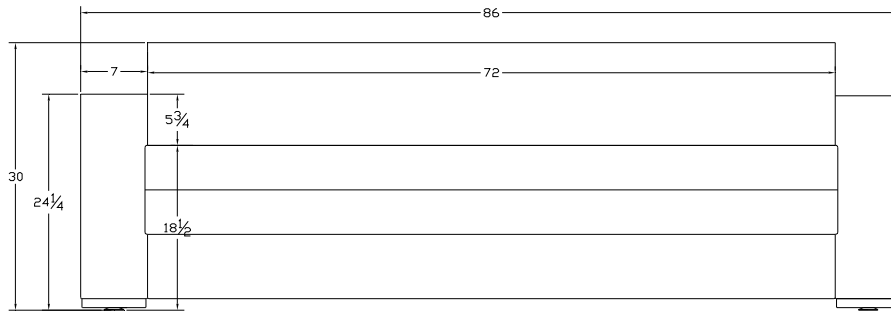

C.O.M. fabric :

It is possible to order these armchairs with the client's fabric, please follow these instructions:

1. Fabric prices are based on 1st price range of each model.

2. Choose the number of yards desired, specific to the chosen model, to be ordered to the supplier.

COM fabrics must be delivered to our factory, shipping, custom duties and brokerage fees "prepaid" with the following information provided: fabric description, number of yards delivered, order number and client name. A late reception of fabric may cause delivery delays.

	5010	5020	5030
	1494	2060	2580
	8 yrds	11 yrds	14 yrds

How to order?

3010FWL

Fabric: Rockwell/Sand #8003, GR2, Base: Whisky
 Fabric Name Fabric color Range Base color

FLINT

**** The VELVA polyurethane foam used meets the standard norms: **
 anti-bacterial and California 117 (fire resistant).**

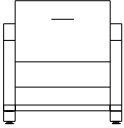
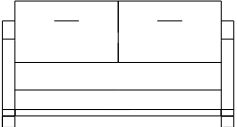
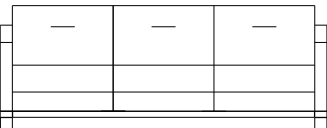
MODELS	DESCRIPTION	RETAIL PRICE					
		GR1	GR2	GR3	GR4	GR5	GR6
Armchair #3010FBW 	Standard armchair components: - Wooden base FBW with 4 legs (Choice of Logiflex wood finish melamine color); - Simple top stitching; - 9 GA springs for the seat and 11 GA for the back; - Medium density Velva foam on seat and back; - Firm density Velva foam on top of the arms; - Frame made out of recycled particles and hardwood for seating base.	1107	1305	1541	1778	1973	2118
* Fabric combinations: use highest price range.							
Love seat #3020FBW 	Standard love seat components: - Wooden base FBW with 4 legs (Choice of Logiflex wood finish melamine color); - Simple top stitching; - 9 GA springs for the seat and 11 GA for the back; - Medium density Velva foam on seat and back; - Firm density Velva foam on top of the arms; - Frame made out of recycled particles and hardwood for seating base.	1524	1689	1909	2129	2679	3119
* Fabric combinations: use highest price range.							
Sofa #3030FBW 	Standard Sofa components: - Wooden base FBW with 4 legs (Choice of Logiflex wood finish melamine color); - Simple top stitching; - 9 GA springs for the seat and 11 GA for the back; - Medium density Velva foam on seat and back; - Firm density Velva foam on top of the arms; - Frame made out of recycled particles and hardwood for seating base.	1918	2116	2353	2589	3790	4516
* Fabric combinations: use highest price range.							

OPTIONS

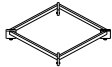

Chrome metal base with 4 legs .

1 place
2 places
3 places

FB1CHR 300
FB2CHR 387
FB3CHR 468

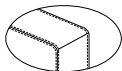

Double top stitching (standard for GR5 and GR6 leathers).

PQD N/C

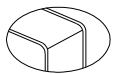

Decorative piping.

CPG N/C

**** Replace the FBW for base wood, if necessary and include the options at the end of the code. Ex.: 3020FB2CHRPQD. Love seat with chrome metal base and double top stitching.**

**** Selection of foam density available (price available upon request only).**

Price upon request for dimension modifications, in length only for armchairs, love seats or sofas with wooden base (not available for chrome finish metal base).

Please note that the warranty does not apply on leather's natural imperfections, such as: scars, marks, and difference in stain within a leather skin or different skins. This specification also applies for standard leather GR5 and Italian leather GR6.

MODELS

Armchair #3010FBW

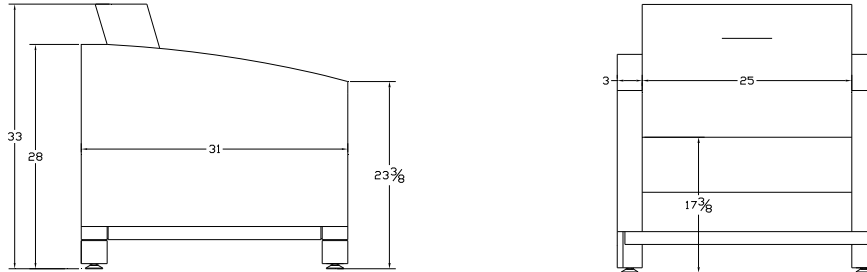

Love seat #3020FBW

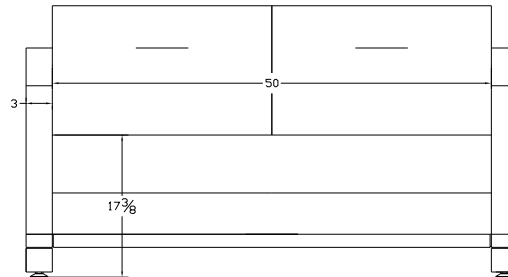

Sofa #3030FBW

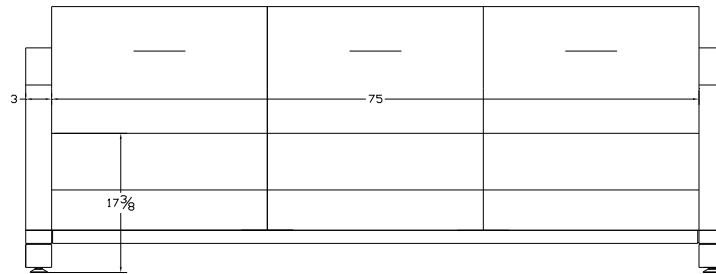

C.O.M. fabric :

It is possible to order these armchairs with the client's fabric, please follow these instructions:

1. Fabric prices are based on 1st price range of each model.

2. Choose the number of yards desired, specific to the chosen model, to be ordered to the supplier.
COM fabrics must be delivered to our factory, shipping, custom duties and brokerage fees "prepaid" with the following information provided: fabric description, number of yards delivered, order number and client name. A late reception of fabric may cause delivery delays.

	3010	3020	3030
	1107	1524	1918
	7 yds	10 yds	13 yds

How to order?

2010FWL
Fabric: Rockwell/Sand #8003, GR2, Base: Whisky
 Fabric Name Fabric color Range Base color

KALYPSO

**** The VELVA polyurethane foam used meets the standard norms: **
 anti-bacterial and California 117 (fire resistant).**

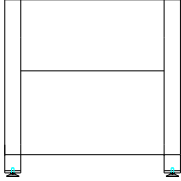
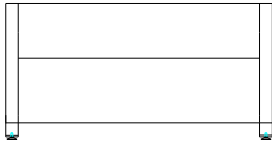
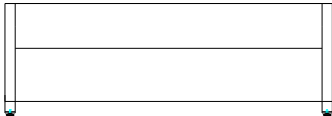
MODELS	DESCRIPTION	RETAIL PRICE					
		GR1	GR2	GR3	GR4	GR5	GR6
Armchair #2010KWLCHR 	Standard armchair components: - 4 wooden legs WLCHR with chrome metal plate (Wood finish: Please refer to the Logiflex color chart); - Double top stitching on sides and back; - Elastic straps on back; - 9 GA springs for the seat; - Firm density Velva foam on seat; - Medium density Velva foam on back; - Frame made out of recycled particles and hardwood for seating base.	979	1117	1293	1463	1804	2008
		* Fabric combinations: use highest price range.					
Love seat #2020KWLCHR 	Standard love seat components: - 4 wooden legs WLCHR with chrome metal plate (Wood finish: Please refer to the Logiflex color chart); - Double top stitching on sides and back; - Elastic straps on back; - 9 GA springs for the seat; - Firm density Velva foam on seat; - Medium density Velva foam on back; - Frame made out of recycled particles and hardwood for seating base.	1238	1386	1595	1799	2519	2728
		* Fabric combinations: use highest price range.					
Sofa #2030KWLCHR 	Standard Sofa components: - 4 wooden legs WLCHR with chrome metal plate (Wood finish: Please refer to the Logiflex color chart); - Double top stitching on sides and back; - Elastic straps on back; - 9 GA springs for the seat; - Firm density Velva foam on seat; - Medium density Velva foam on back; - Frame made out of recycled particles and hardwood for seating base.	1540	1760	2052	2310	2750	3080
		* Fabric combinations: use highest price range.					

OPTIONS



Set of 4 casters in chromed metal with PVC (imitating rubber).
 of 3-1/2" diameter x 5"H. Each caster can support 154 pds.

WCHR 385 / set of 4



Football form backrest with medium density Velva foam,
 size of 16"L x 8-5/8"H (Back rest are sold separately).

	GR1	GR2	GR3	GR4	GR5	GR6
APD	242	268	298	330	363	403

**** Replace the WLCHR for casters WCHR, if necessary, and include the backrest option at the end of the code. Ex.: 2020WCHRAPD. Love seat with casters and backrest.**

**** Selection of foam density available (price available upon request only).**

Price upon request for dimension modifications for armchairs, love seats and sofas.

Please note that the warranty does not apply on leather's natural imperfections, such as: scars, marks, and difference in stain within a leather skin or different skins. This specification also applies for standard leather GR5 and Italian leather GR6.

MODELS

Armchair #2010KWLCHR

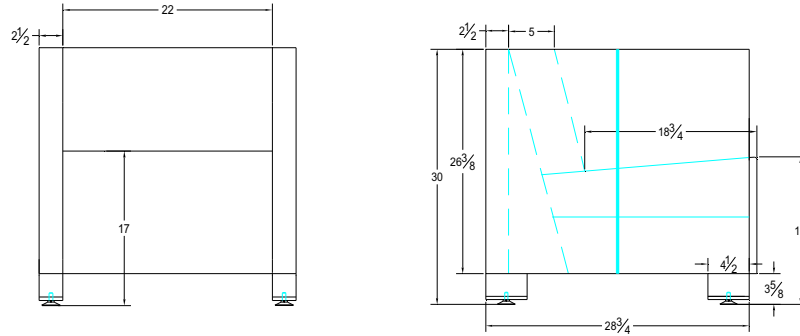

Love seat #2020KWLCHR

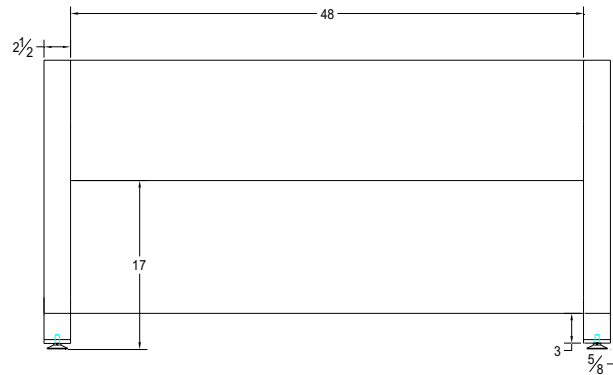

Sofa #2030KWLCHR

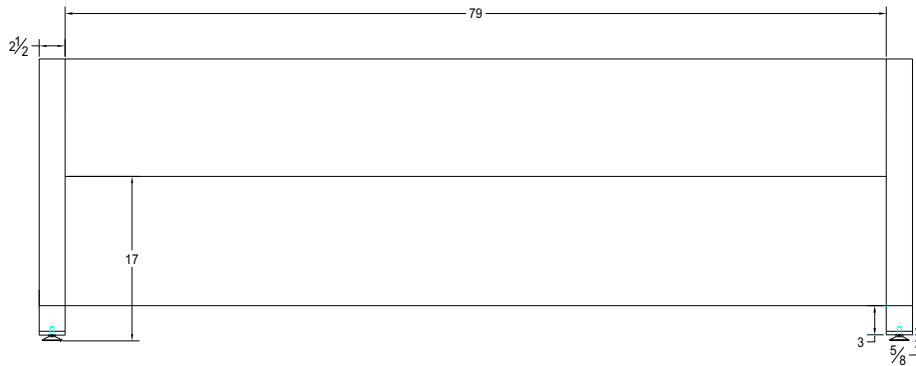

C.O.M. fabric :

It is possible to order these armchairs with the client's fabric, please follow these instructions:

1. Fabric prices are based on 1st price range of each model.

2. Choose the number of yards desired, specific to the chosen model, to be ordered to the supplier.

COM fabrics must be delivered to our factory, shipping, custom duties and brokerage fees "prepaid" with the following information provided: fabric description, number of yards delivered, order number and client name. A late reception of fabric may cause delivery delays.

2010	2020	2030	APD
979	1238	1540	242
5 yds	8 yds	10 yds	1 yd



How to order?

4010MPAL

Fabric: Rockwell/Sand #8003, GR2, Base: Whisky
 Fabric name Fabric color Range Base color

MONRO

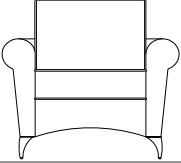
**** The VELVA polyurethane foam used meets the standard norms: **
 anti-bacterial and California 117 (fire resistant).**

MODELS	DESCRIPTION	RETAIL PRICE					
		GR1	GR2	GR3	GR4	GR5	GR6
Armchair #4010MPAL 	Standard armchair components: - 4 metal legs MPAL, polished aluminum; - Decorative piping on seat and back; - Elastic straps on seat; - Medium density Velva foam on seat and back; - Frame made out of recycled particles.	1301	1422	1560	1697	2316	2506
* Fabric combinations: use highest price range.							
Love seat #4020MPAL 	Standard love seat components: - 4 metal legs MPAL, polished aluminum; - Decorative piping on seat and back; - Elastic straps on seat; - Medium density Velva foam on seat and back; - Frame made out of recycled particles.	1899	2064	2284	2504	3328	3771
* Fabric combinations: use highest price range.							

OPTIONS



4 wooden legs (sold in packages of 4 only available in Logiflex wood finish melamine color).

MWL 289 / set of 4

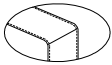

Simple top stitching on seat and back.

PQS N/C

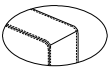

Double top stitching on seat and back (standard for GR5 and GR6 leathers).

PQD N/C

**** Replace the MPAL for metal legs, if necessary and include **
 the options at the end of the code Ex.: 4010MWL.
 Armchair with wooden legs.**

**** Selection of foam density available (price available upon request only).**

**Please note that the warranty does not apply
 on leather's natural imperfections, such as: scars, marks,
 and difference in stain within a leather skin or different skins.
 This specification also applies for standard leather GR5
 and Italian leather GR6.**

MODELS

Armchair #4010MPAL

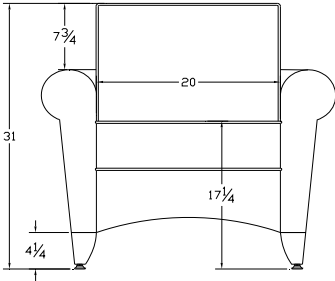

Love seat #4020MPAL

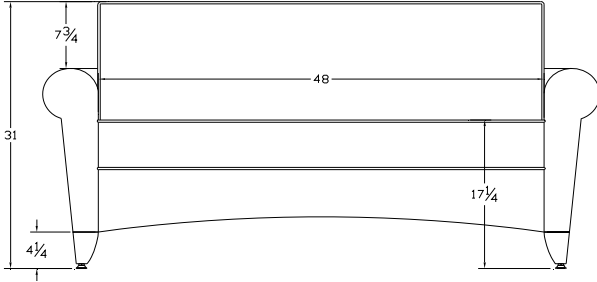

C.O.M. fabric :

It is possible to order these armchairs with the client's fabric, please follow these instructions:

- 1. Fabric prices are based on 1st price range of each model.
- 2. Choose the number of yards desired, specific to the chosen model, to be ordered to the supplier.
COM fabrics must be delivered to our factory, shipping, custom duties and brokerage fees "prepaid" with the following information provided: fabric description, number of yards delivered, order number and client name. A late reception of fabric may cause delivery delays.

	4010	4020
	1301	1899
	7 yds	10 yds

How to order?

1010RWL

Fabric: Rockwell/Sand #8003, GR2, Legs: Whisky
 Fabric Name Fabric color Range Legs color

ROBI

**** The VELVA polyurethane foam used meets the standard norms: **
 anti-bacterial and California 117 (fire resistant).**

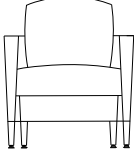
MODELS	DESCRIPTION	RETAIL PRICE					
		GR1	GR2	GR3	GR4	GR5	GR6
Armchair #1010RWL 	Standard armchair components: - 4 wooden legs RWL (Choice of Logiflex wood finish melamine color); - 9 GA springs for the seat and 11 GA springs for back; - Medium density Velva foam on seat and back; - Firm density Velva foam on top of the arms; - Frame made out of hardwood and plywood.	1183	1276	1386	1496	1781	1987
		* Fabric combinations: use highest price range.					
OPTIONS							

**** Selection of foam density available (price available upon request only).**

Please note that the warranty does not apply on leather's natural imperfections, such as: scars, marks, and difference in stain within a leather skin or different skins. This specification also applies for standard leather GR5 and Italian leather GR6.

MODELS

Armchair #1010RWL

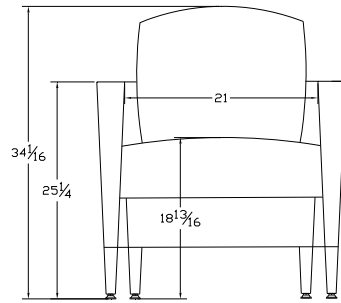
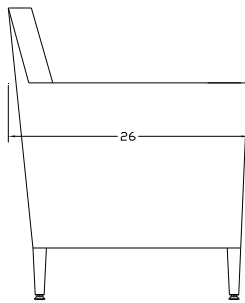

C.O.M. fabric :

It is possible to order these armchairs with the client's fabric, please follow these instructions:

1. Fabric prices are based on 1st price range of the model.

2. Choose the number of yards desired, specific to the chosen model, to be ordered to the supplier.
COM fabrics must be delivered to our factory, shipping, custom duties and brokerage fees "prepaid" with the following information provided: fabric description, number of yards delivered, order number and client name. A late reception of fabric may cause delivery delays.

1010

1183

5 yds

How to order?

803

Fabric: Rockwell/Sand #8003, GR2, Base: Whisky
 Fabric name Fabric color Range Base color

SEDIA

**** The VELVA polyurethane foam used meets the standard norms: **
 anti-bacterial and California 117 (fire resistant).**

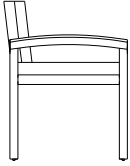
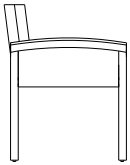
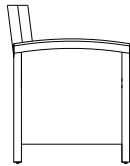
MODELS	DESCRIPTION	RETAIL PRICE					
		GR1	GR2	GR3	GR4	GR5	GR6
Chair #803 	Standard components of wood chair with arms: - Simple top stitching; - Elastic straps on seat and back; - Medium density Velva foam on seat; - Low density Velva foam on back; - Frame made out of hardwood (Choice of Logiflex wood finish melamine color).	579	583	644	704	825	946
		* Fabric combinations: use highest price range.					
Chair #804 	Standard components of wood chair with arms with half padded sides: - Simple top stitching; - Elastic straps on seat and back; - Medium density Velva foam on seat; - Low density Velva foam on back; - Frame made out of hardwood (Choice of Logiflex wood finish melamine color).	713	768	850	933	946	1007
		* Fabric combinations: use highest price range.					
Chair #805 	Standard components of wood chair with arms including padded sides: - Simple top stitching; - Elastic straps on seat and back; - Medium density Velva foam on seat; - Low density Velva foam on back; - Frame made out of hardwood (Choice of Logiflex wood finish melamine color).	801	856	938	1021	1128	1188
		* Fabric combinations: use highest price range.					

OPTIONS

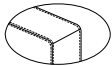

Double top stitching (standard for GR5 and GR6 leathers).

PQD N/C

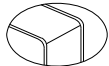

Decorative piping.

CPG N/C

**** Include the options at the end of the code Ex.: 803PQD. **
 Chair with arms and double top stitching.**

**** Selection of foam density available (price available upon request only).**

Please note that the warranty does not apply on leather's natural imperfections, such as: scars, marks, and difference in stain within a leather skin or different skins. This specification also applies for standard leather GR5 and Italian leather GR6.

MODELS

Chair #803

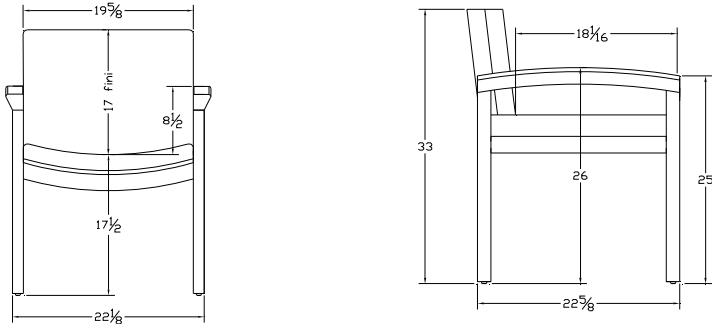

Chair #804

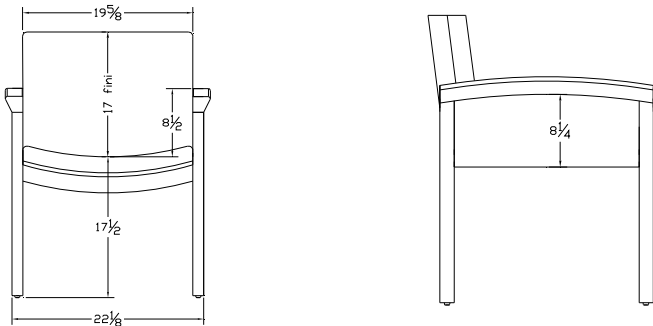

Chair #805

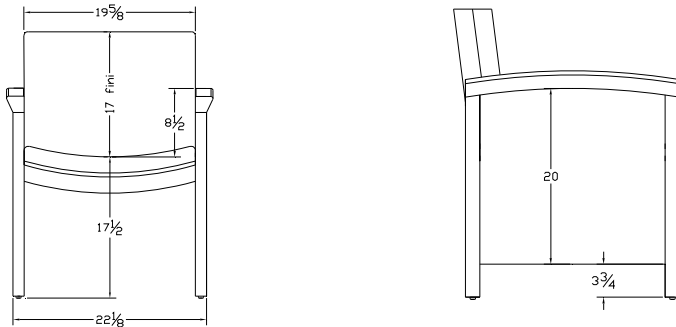

C.O.M. fabric :

It is possible to order these armchairs with the client's fabric, please follow these instructions:

1. Fabric prices are based on 1st price range of each model.
2. Choose the number of yards desired, specific to the chosen model, to be ordered to the supplier.
COM fabrics must be delivered to our factory, shipping, custom duties and brokerage fees "prepaid" with the following information provided: fabric description, number of yards delivered, order number and client name. A late reception of fabric may cause delivery delays.

803	804	805
579	713	801
2 yds	3 yds	4 yds

How to order?







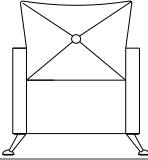
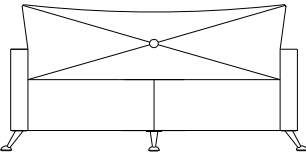
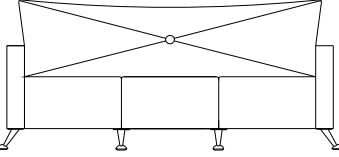

6750PM

Fabric: Rockwell/Sand #8003, GR2

Fabric name Fabric color Range

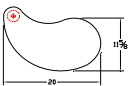
STELLI

**** The VELVA polyurethane foam used meets the standard norms: **
anti-bacterial and California 117 (fire resistant).**

MODELS	DESCRIPTION	RETAIL PRICE					
		GR1	GR2	GR3	GR4	GR5	GR6
Armchair #6750PM 	Standard armchair components: - 2 metal legs PM in front and 2 levelers in the back; - Elastic straps on seat and back; - Medium density Velva foam on seat and back; - Firm density Velva foam on top of the arms; - Standard button and " X" stitch in the back; - Frame made out of recycled particles.	1130	1223	1333	1443	1714	2002
		* Fabric combinations: use highest price range.					
Love seat #6753PM 	Standard love seat components: - 3 metal legs PM in front and 2 levelers in the back; - Elastic straps on seat and back; - Medium density Velva foam on seat and back; - Firm density Velva foam on top of the arms; - Standard button and " X" stitch in the back; - Frame made out of recycled particles.	1615	1752	1917	2082	2580	2811
		* Fabric combinations: use highest price range.					
Sofa #6757PM 	Standard sofa components: - 4 metal legs PM in front and 2 levelers in the back; - Elastic straps on seat and back; - Medium density Velva foam on seat and back; - Firm density Velva foam on top of the arms; - Standard button and " X" stitch in the back; - Frame made out of recycled particles.	1817	1982	2202	2422	3306	3911
		* Fabric combinations: use highest price range.					
OPTIONS							
	Wooden leg with 2-7/8" x 2/8"x 4-1/2" levelers for #6750 and 3-7/8" x 3-7/8"x4 1/2 levelers for #6753 and #6757. (Choice of Logiflex wood finish melamine color)	WL	55 / Leg				
	Queen-Ann leg, aluminum polished finish, 3-7/8" high.	QAP	55 / Leg				
	2 wooden armrests (Choice of Logiflex wooden finish melamine color).	WA	95 / Set of 2				
	Kidney shaped pivoting shelf made out of hardwood with a thickness of 3/4", standard right side. (Choice of Logiflex wood finish melamine color)	SPR	243				
	Kidney shaped pivoting shelf made out of hardwood with a thickness of 3/4", standard left side. (Choice of Logiflex wood finish melamine color)	SPL	243				
	Simple top stitching.	PQS	N/C				
	Double top stitching (standard for GR5 and GR6 leathers).	PQD	N/C				
	No buttons and no "X" in the back.	SBX	N/C				
<p>** Replace the PM for metal legs, if necessary and include ** the options at the end of the code Ex: 6750WLWAPQDSBX. Armchair with wooden legs, wooden arms, double top stitching, back with no buttons and no "X" stitch.</p> <p>** Selection of foam density available (price available upon request only).</p> <p>Price upon request for dimension modifications, in length only for armchairs, love seats or sofas.</p>							
<p>Please note that the warranty does not apply on leather's natural imperfections, such as: scars, marks, and difference in stain within a leather skin or different skins. This specification also applies for standard leather GR5 and Italian leather GR6.</p>							

MODELS

Armchair #6750PM

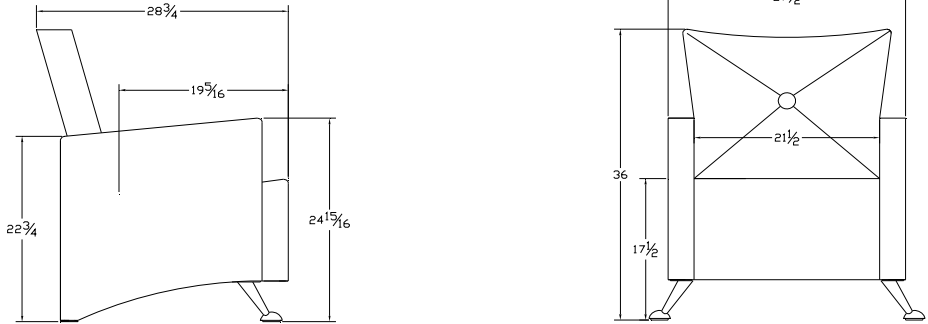

Love seat #6753PM

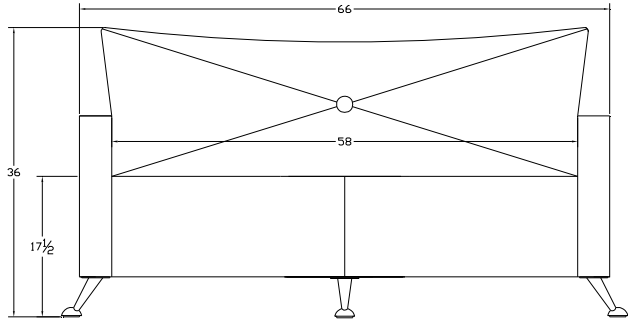

Sofa #6757PM

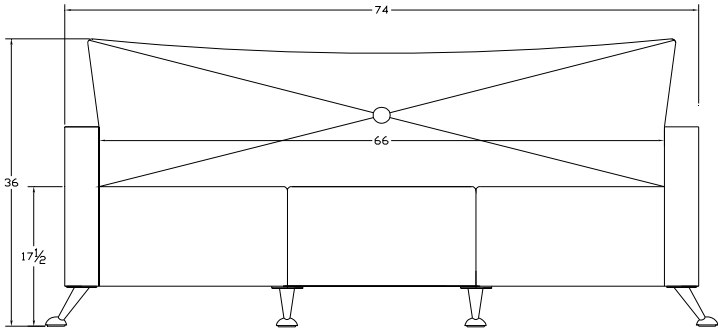

C.O.M. fabric :

It is possible to order these armchairs with the client's fabric, please follow these instructions:

1. Fabric prices are based on 1st price range of each model.
2. Choose the number of yards desired, specific to the chosen model, to be ordered to the supplier.
COM fabrics must be delivered to our factory, shipping, custom duties and brokerage fees "prepaid" with the following information provided: fabric description, number of yards delivered, order number and client name. A late reception of fabric may cause delivery delays.

6750	6753	6757
1130	1615	1817
5 yds	7 yds	9 yds

How to order?



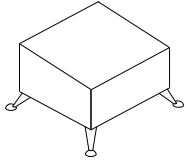
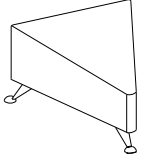
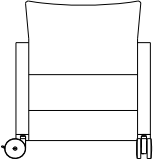

6755SML
Fabric: Rockwell/Sand #8003, GR2
 Fabric name Fabric color Range

STELLI

**** The VELVA polyurethane foam used meets the standard norms: ****
anti-bacterial and California 117 (fire resistant).

MODELS	DESCRIPTION	RETAIL PRICE					
		GR1	GR2	GR3	GR4	GR5	GR6
Squared Ottoman #6755SPM 	Standard square Ottoman components: - 4 metal legs PM; - Medium density Velva foam; - Frame made out of recycled particles.	558	608	703	798	1126	1278
		* Fabric combinations: use highest price range.					
Triangular Ottoman #6755TPM 	Standard triangular Ottoman components: - 3 metal legs PM; - Medium density Velva foam; - Frame made out of recycled particles.	517	570	659	760	1089	1228
		* Fabric combinations: use highest price range.					
Armchair 6759 	Standard armchair with back handle components: - 2 standard wheels in front and 2 levelers in the back; - Elastic straps on seat; - Medium density Velva foam on seat and back; - Firm density Velva foam on top of the arms of the chair; - Fabric Handle in the top of the back; - Frame made out of recycled particles.	902	924	1051	1241	1747	1936
		* Fabric combinations: use highest price range.					

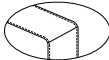
OPTIONS

	Wooden leg with 2-7/8"x2-7/8"x4-1/2" levelers for squared ottoman only(Choice of Logiflex wood finish melamine color)	WL	55	/ Leg
	Queen-Ann leg, aluminum polished finish, 3-7/8" high for ottomans only.	QAP	55	/ Leg
	Hard surface wheels.	HF	N/C	
	Simple top stitching for ottomans only.	PQS	N/C	
	Double top stitching for ottomans only (standard for GR5 and GR6 leather).	PQD	N/C	

**** Replace the PM for metal legs, if necessary and include ****
the options at the end of the code Ex: 6755SWL.
Square ottoman with yellow birch legs.

**** Selection of foam density available (price available upon request only).**

Price upon request for dimension modifications.

Please note that the warranty does not apply
on leather's natural imperfections, such as: scars, marks,
and difference in stain within a leather skin or different skins.
This specification also applies for standard leather GR5
and Italian leather GR6.

MODÈLES

Square ottoman #6755SPM

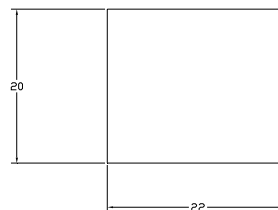
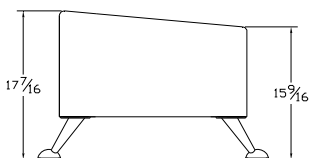
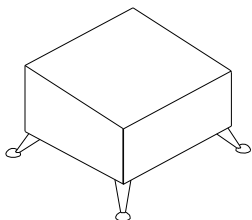

Triangular ottoman #6755TPM

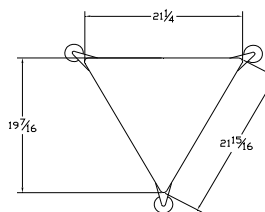
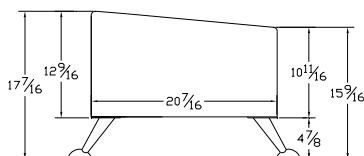
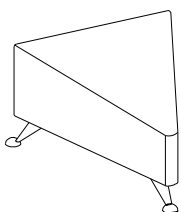

Armchair #6759

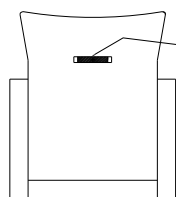
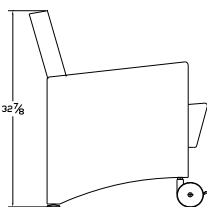

Back view:
Leather handle

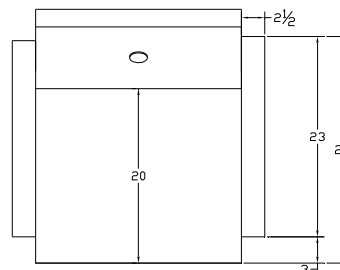
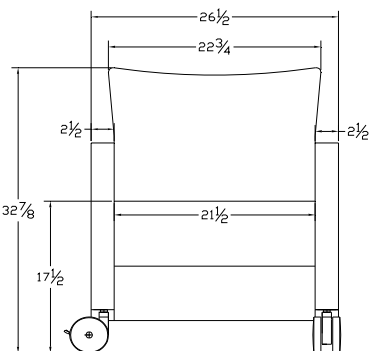

C.O.M. fabric :

It is possible to order these armchairs with the client's fabric, please follow these instructions:

1. Fabric prices are based on 1st price range of each model.
2. Choose the number of yards desired, specific to the chosen model, to be ordered to the supplier.
COM fabrics must be delivered to our factory, shipping, custom duties and brokerage fees "prepaid" with the following information provided: fabric description, number of yards delivered, order number and client name. A late reception of fabric may cause delivery delays.

6755S	6755T	6759
558	517	902
3 yds	3 yds	4 yds

How to order?

1050TWL

Fabric: Rockwell/Sand #8003, GR2, Legs: Whisky
 Fabric name Fabric color Range Legs color

TOBI

**** The VELVA polyurethane foam used meets the standard norms: **
 anti-bacterial and California 117 (fire resistant).**

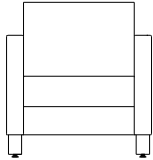
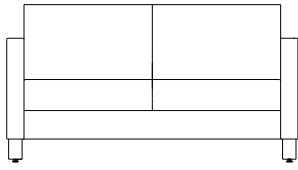
MODELS	DESCRIPTION	RETAIL PRICE					
		GR1	GR2	GR3	GR4	GR5	GR6
Armchair #1050TWL 	Standard armchair components: - 4 wooden legs TWL (Choice of Logiflex wood finish melamine color) - Double top stitching; - 9 GA springs for the seat and 11 GA springs for back; - Medium density Velva foam on seat and back; - Firm density Velva foam on top of the arms; - Seat and back frame made out of hardwood; - Arm frame made out of recycled particles.	967	1060	1170	1280	1551	1672
* Fabric combinations: use highest price range.							
Love seat #1060TWL 	Standard love seat components: - 4 wooden legs TWL (Choice of Logiflex wood finish melamine color) - Double top stitching; - 9 GA springs for the seat and 11 GA springs for back; - Medium density Velva foam on seat and back; - Firm density Velva foam on top of the arms; - Seat and back frame made out of hardwood; - Arm frame made out of recycled particles.	1246	1384	1549	1714	2035	2156
* Fabric combinations: use highest price range.							

OPTIONS

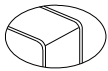

Decorative piping.

CPG **N/C**

**** Include the option at the end of the code Ex.: 1050CPG. **
 Armchair with decorative piping.**

**** Selection of foam density available (price available upon request only).**

Price upon request for dimension modifications, in length only for armchairs and love seats.

Please note that the warranty does not apply on leather's natural imperfections, such as: scars, marks, and difference in stain within a leather skin or different skins. This specification also applies for standard leather GR5 and Italian leather GR6.

MODELS

Armchair#1050TWL

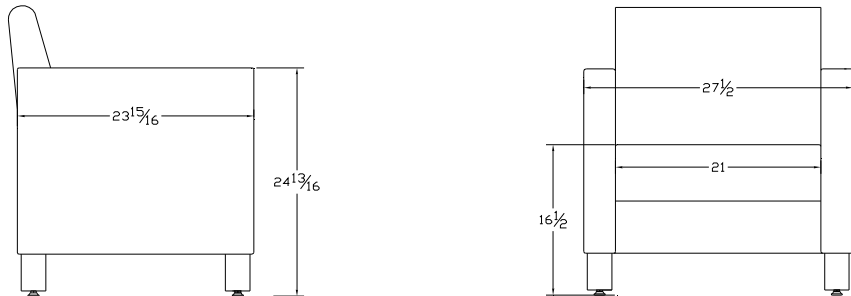

Love seat #1060TWL

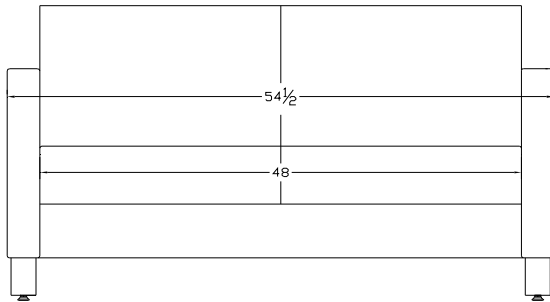

C.O.M. fabric :

It is possible to order these armchairs with the client's fabric, please follow these instructions:

1. Fabric prices are based on 1st price range of each model.
2. Choose the number of yards desired, specific to the chosen model, to be ordered to the supplier.
COM fabrics must be delivered to our factory, shipping, custom duties and brokerage fees "prepaid" with the following information provided: fabric description, number of yards delivered, order number and client name. A late reception of fabric may cause delivery delays.

	1050	1060
	967	1246
	5 yds	7 yds

**M
O
D
U
L
A
R**

**S
E
C
T
I
O
N**

MODELS

The infiniti serie is a flexible tool, having only your imagination to limit its modular conception possibilities. The benches with numerous shapes will easily adapt to any type of environment.

Use it to enhance any office environment, institutional center, resting area, public places or even reception spaces. Through its contemporary design, comfortable and affordable features respecting environmental concerns, here is a series that will not leave you feeling indifferent. Below are a very small sampling of possibilities available.

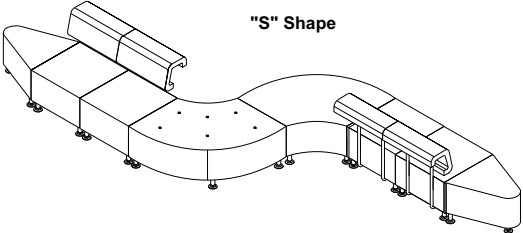

"S" Shape

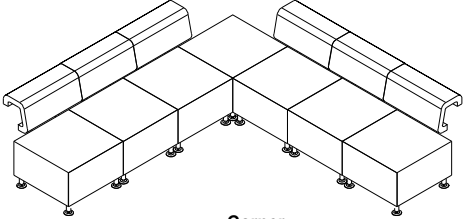

Corner

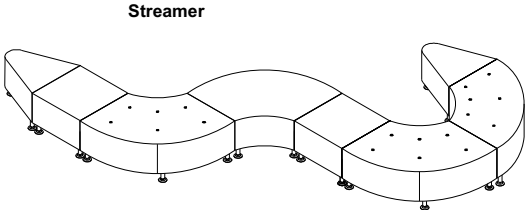

Streamer

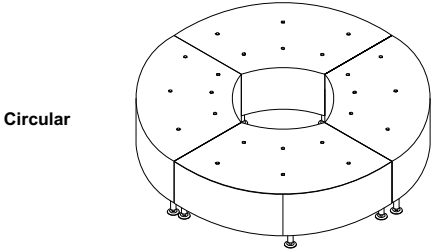

Circular

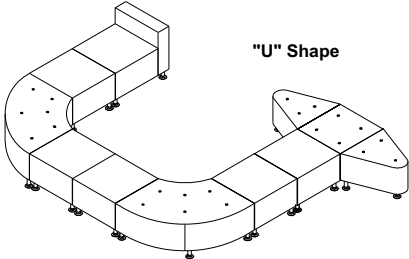

"U" Shape

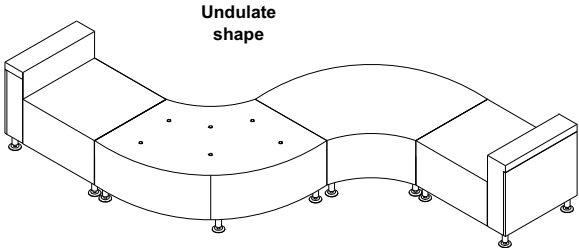

**Undulate
shape**

How to order?

010BSQ24

Tissu: Rockwell/Sand #8003, GR2
Fabric name Range Fabric color

INFINITI
BENCH

** The VELVA polyurethane foam used meets the standard norms: **
anti-bacterial and California 117 (fire resistant).

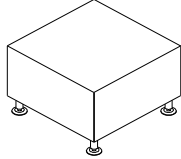
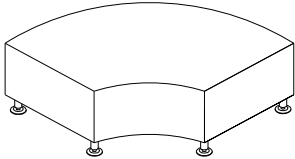
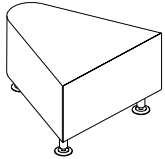
MODEL	DESCRIPTION	RETAIL PRICE					
		GR1	GR2	GR3	GR4	GR5	GR6
Square bench 010BSQ24 	Standard components for the 24" x 24" square bench: - 4 brushed chrome metal legs; - Simple top stitching; - Elastic straps on seat; - Firme density Velva foam on seat; - 1/2" thick polyester on sides; - Frame made out of recycled particles.	585	631	716	813	1128	1261
		* Fabric combinations: use highest price range.					
Arched bench 020BARC 	Standard components for the arched bench: - 5 brushed chrome metal legs; - Simple top stitching; - Elastic straps on seat; - Firme density Velva foam on seat; - 1/2" thick polyester on sides; - Frame made out of recycled particles.	1055	1137	1225	1313	1515	1660
		* Fabric combinations: use highest price range.					
Oval bench 030BOV 	Standard components for the oval bench: - 3 brushed chrome metal legs; - Simple top stitching; - Elastic straps on seat; - Firme density Velva foam on seat; - 1/2" thick polyester on sides; - Frame made out of recycled particles.	597	652	735	817	1140	1273
		* Fabric combinations: use highest price range.					

OPTIONS

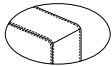

Double top stitching (standard for GR5 and GR6 leathers).

PQD N/C



Upholstered buttons on top.

DBC N/C

*Decorative sewing on top (price and models upon request).

** Include the options at the end of the codeEx.: 040BSUADBC. **
Square bench with padded arms and upholstered buttons on top.

Price upon request for dimension modifications, in length and depth of the square bench only (not available for arched and oval bench).

Please note that the warranty does not apply on leather's natural imperfections, such as: scars, marks, and difference in stain within a leather skin or different skins. This specification also applies for standard leather GR5 and Italian leather GR6.

MODELS

Square bench 010BSQ24

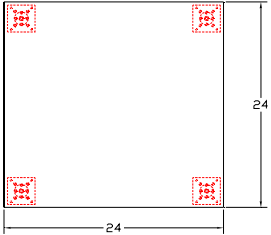
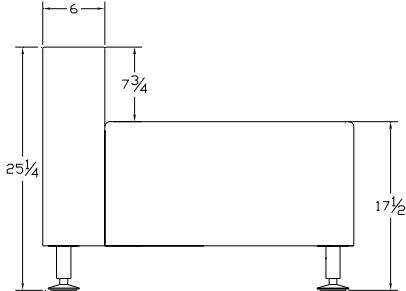

Arched bench 020BARC

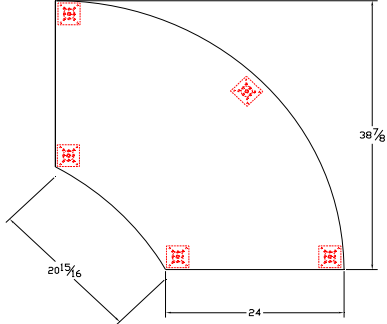
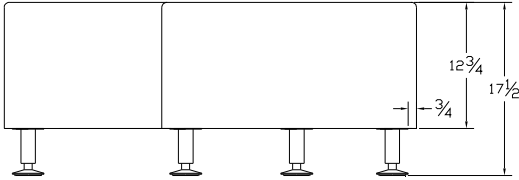

Oval bench 030BOV

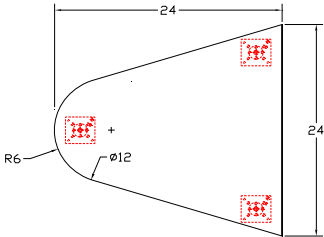
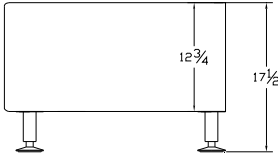

C.O.M. fabric :

It is possible to order these armchairs with the client's fabric, please follow these instructions:

1. Fabric prices are based on 1st price range of each model.
2. Choose the number of yards desired, specific to the chosen model, to be ordered to the supplier.
COM fabrics must be delivered to our factory, shipping, custom duties and brokerage fees "prepaid" with the following information provided: fabric description, number of yards delivered, order number and client name. A late reception of fabric may cause delivery delays.

	010	020	030
	585	1055	597
	2 yrds	3 yrds	2 yrds

How to order?

040BSUA
Fabric: Rockwell/Sand #8003, GR2
 Fabric name Fabric color Range

**INFINITI
 BENCH AND ARM UNITY**

**** The VELVA polyurethane foam used meets the standard norms: **
 anti-bacterial and California 117 (fire resistant).**

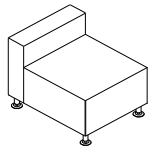
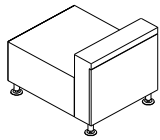
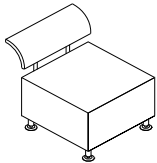
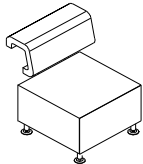
MODEL	DESCRIPTION	RETAIL PRICE					
		GR1	GR2	GR3	GR4	GR5	GR6
Square bench with padded arm 040BSUA 	Standard components of square bench with padded arm : - 4 brushed chrome metal legs; - Simple top stitching; - Elastic straps on seat; - Firm density Velva foam on seat and arm; - 1/2" thick polyester on sides of the bench; - Arm and seat frames made out of recycled particles.	839	933	1043	1153	1660	1866
* Fabric combinations: use highest price range.							
Square bench with padded arm and melamine 045BSUAM 	Standard components of square bench with padded arm and melamine: - 4 brushed chrome metal legs; - Simple top stitching; - Elastic straps on seat; - Firm density Velva foam on seat and arm; - 1/2" thick polyester on sides of the bench; - 5/8" thick melamine back and 24"L x 17"H height (Choice of Logiflex wood finish melamine color); - Arm and seat frames made out of recycled particles.	954	1047	1157	1267	1769	1975
* Fabric combinations: use highest price range.							
Square bench with curved back 050BCA 	Standard components of square bench with curved arm : - 4 brushed chrome metal legs; - Simple topstitching; - Elastic straps on seat; - Firm density Velva foam on seat and arm; - 1/2" thick polyester on sides of the bench; - Satin nickel 16 GA metal tube 3/4" diameter; - Arm frame made out of plywood; - Seat frame made out of recycled particles.	983	1077	1187	1297	1782	1986
* Fabric combinations: use highest price range.							
Square bench with curved back 055BCB 	Standard components of square bench with curved back : - 4 brushed chrome metal legs; - Simple top stitching; - Elastic straps on seat; - Firm density Velva foam on seat and arm; - 1/2" thick polyester on sides of the bench; - Satin nickel 16 GA metal tube 3/4" diameter; - Arm frame made out of plywood; - Seat frame made out of recycled particles.	1004	1098	1208	1318	1817	2023
* Fabric combinations: use highest price range.							

OPTIONS

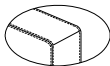

Double top stitching (standard for GR5 and GR6 leathers).

PQD N/C



Upholstered buttons on top.

DBC N/C

***Decorative sewing on top (price and models upon request).**

**** Include the options at the end of the codeEx.: 040BSUADBC. **
 Square bench with padded arms and upholstered buttons on top.**

**Please note that the warranty does not apply
 on leather's natural imperfections, such as: scars, marks,
 and difference in stain within a leather skin or different skins.
 This specification also applies for standard leather GR5
 and Italian leather GR6.**

MODELS

Square bench with padded arm
040BSUA

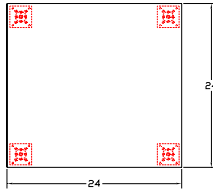
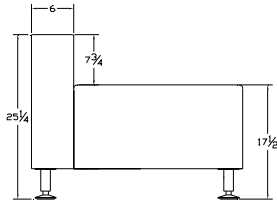

Square bench with padded arm and melamine 045BSUAM

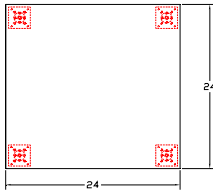
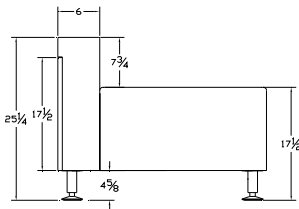

Square bench with curved arm
050BCA

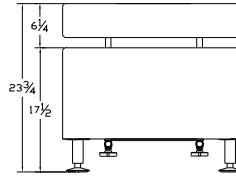
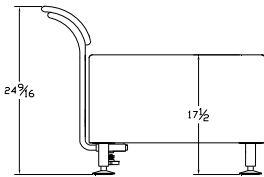

Square bench with curved back
055BCB

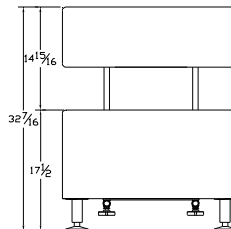
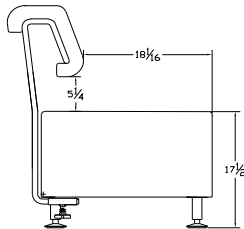

C.O.M. fabric :

It is possible to order these armchairs with the client's fabric, please follow these instructions:

1. Fabric prices are based on 1st price range of each model.

040	045	050	055
839	954	983	1004

2. Choose the number of yards desired, specific to the chosen model, to be ordered to the supplier.

3 yds	3 yds	3 yds	3 yds
-------	-------	-------	-------

COM fabrics must be delivered to our factory, shipping, custom duties and brokerage fees "prepaid" with the following information provided: fabric description, number of yards delivered, order number and client name. A late reception of fabric may cause delivery delays.

How to order?

SUA
 Tissu: Rockwell/Sand #8003, GR2
 Fabric name Fabric color Range

**INFINITI
 ARM AND BACK**

**** The VELVA polyurethane foam used meets the standard norms: **
 anti-bacterial and California 117 (fire resistant).**

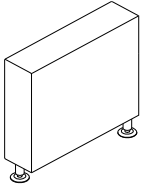
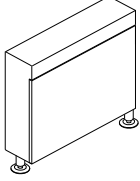
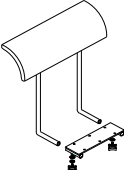
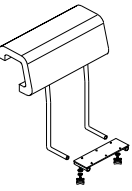
MODELS	DESCRIPTION	RETAIL PRICE					
		GR1	GR2	GR3	GR4	GR5	GR6
Padded arm SUA 	Standard components of padded arm : (Must be combined with benches of page 26) - Simple top stitching; - Firm density Velva foam on arm; - Arm and seat frames made out of recycled particles. ** For the arched bench, indicate on which side ** you want the back installed.	293	317	365	414	571	644
Padded arm with melamine SUAM 	Standard fabrication of padded arm : (Must be combined with benches on page 26) - Simple top stitching; - Firm density Velva foam on arm; - 5/8" thick melamine back and 24"L x 17"H height (Choice of Logiflex wood finish melamine color); - Arm and seat frames made out of recycled particles. ** For the arched bench, indicate on which side ** you want the back installed.	408	426	474	523	680	752
Curved arm CA 	Standard fabrication of curved arm : - Simple top stitching; - Firm density Velva foam on arm; - Nickel satin 16 GA metal tube with 7/8" diameter; - 1/4" thick steel fastener with two plastic handles; - Arm frame made out of plywood. ** For the arched bench, indicate on which side ** you want the back installed.	438	452	498	545	693	763
Curved back CB 	Standard fabrication of curved back : - Simple top stitching; - Firm density Velva foam on back seat; - Satin nickel 16 GA metal tube 7/8" diameter; - 1/4" thick steel fastener with two plastic handles; - Arm frame made out of plywood. ** For the arched bench, indicate on which side ** you want the back installed.	459	474	523	571	728	801

OPTIONS

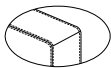

Double top stitching (standard for GR5 and GR6 leathers).

PQD

N/C

Please note that the warranty does not apply on leather's natural imperfections, such as: scars, marks, and difference in stain within a leather skin or different skins. This specification also applies for standard leather GR5 and Italian leather GR6.

MODELS	RETAIL PRICE
--------	--------------

Padded arm SUA

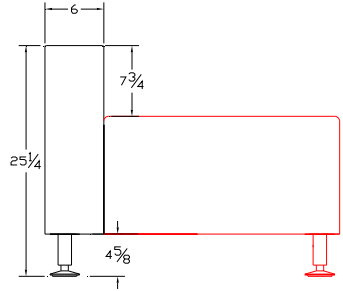

Padded arm with melamine SUAM

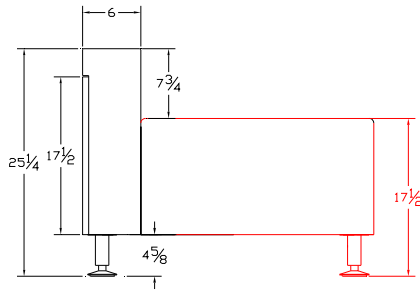

Curved arm CA

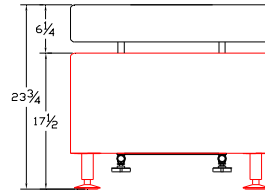
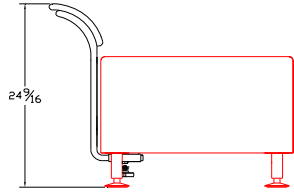

Curved back CB

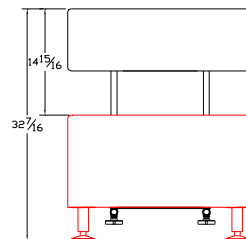
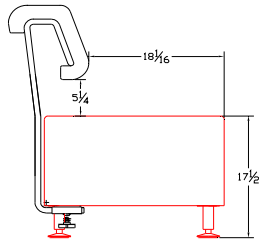

C.O.M. fabric :

It is possible to order these armchairs with the client's fabric, please follow these instructions:

1. Fabric prices are based on 1st price range of each model.
2. Choose the number of yards desired, specific to the chosen model, to be ordered to the supplier.
COM fabrics must be delivered to our factory, shipping, custom duties and brokerage fees "prepaid" with the following information provided: fabric description, number of yards delivered, order number and client name. A late reception of fabric may cause delivery delays.

SUA	SUAM	CA	CB
293	408	438	459
1 yrd	1 yrd	1 yrd	1 yrd

**T
A
B
L
E**

**S
E
C
T
I
O
N**

How to order?

MA - 181421UTPM, Color: Whisky

Series Product code Melamine color

UTILITY TABLES
MANHATTAN

** Please refer to the Logiflex color chart **
for the choice of melamine color choices

melamine		stratified	melamine		stratified
MA		MAL	MAW		MAWL
1-5/8"		1-9/16"	1-5/8"		1-9/16"
MAR		MARL	MAX		MAXL

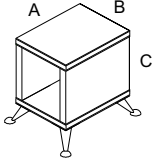
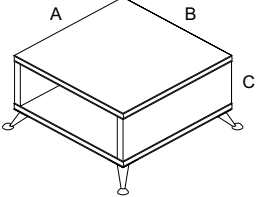
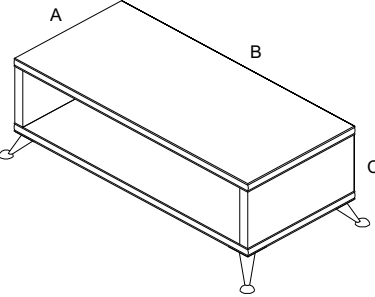
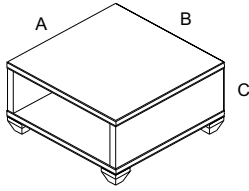
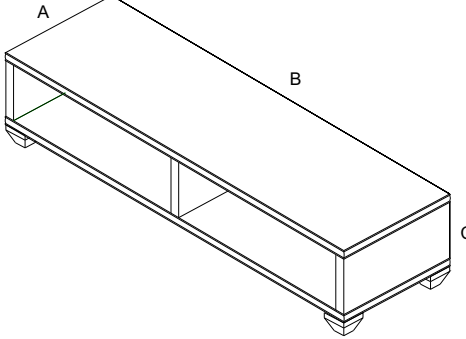
DESCRIPTION	PRODUCT	RETAIL PRICE			
Only with brushed metal legs 	A B C				
	181421UTPM	809	828	1064	1084
 	242418UTPM	748	792	1156	1199
	303018UTPM	814	881	1323	1390
	306018UTPM	927	1063	1692	1826
	307218UTPM	1049	1211	1916	2078
	181421UTWL	809	828	1064	1084
	242418UTWL	748	792	1156	1199
 	303018UTWL	814	881	1323	1390
	306018UTWL	927	1063	1692	1826
	307218UTWL	1049	1211	1916	2078

How to order?

MDFB - 242418UTFBCHR, Color: Whisky

Series Product code Melamine and base color

UTILITY TABLES
FLINT

** Please refer to the Logiflex color chart **
for the choice of wood color

1-1/16"
MDFB

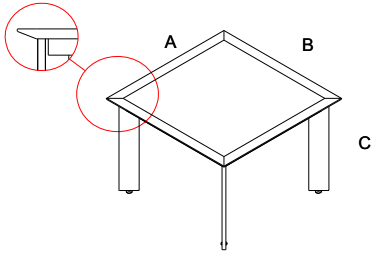
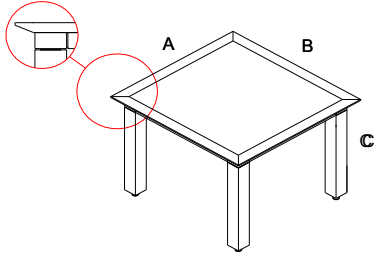
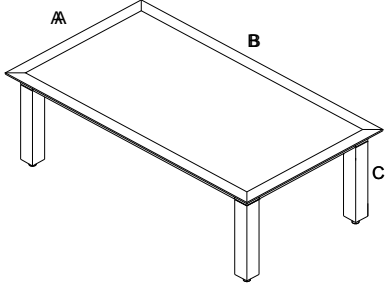
DESCRIPTION	PRODUCT	RETAIL PRICE																			
<p>MDF top with wood veneer and chamfer edge with a chrome metal base</p> 	<p>A B C</p> <table border="1"> <tr> <td>242418UTFBCHR</td> <td>970</td> <td></td> </tr> <tr> <td>303018UTFBCHR</td> <td>1084</td> <td></td> </tr> <tr> <td>242424UTFBCHR</td> <td>1000</td> <td></td> </tr> <tr> <td>303024UTFBCHR</td> <td>1118</td> <td></td> </tr> </table>	242418UTFBCHR	970		303018UTFBCHR	1084		242424UTFBCHR	1000		303024UTFBCHR	1118									
242418UTFBCHR	970																				
303018UTFBCHR	1084																				
242424UTFBCHR	1000																				
303024UTFBCHR	1118																				
<p>MDF top with wood veneer and chamfer edge with a wooden base</p>  	<table border="1"> <tr> <td>242418UTFBW</td> <td>620</td> <td></td> </tr> <tr> <td>303018UTFBW</td> <td>755</td> <td></td> </tr> <tr> <td>242424UTFBW</td> <td>667</td> <td></td> </tr> <tr> <td>303024UTFBW</td> <td>790</td> <td></td> </tr> <tr> <td>306018UTFBW</td> <td>1255</td> <td></td> </tr> <tr> <td>307218UTFBW</td> <td>1368</td> <td></td> </tr> </table>	242418UTFBW	620		303018UTFBW	755		242424UTFBW	667		303024UTFBW	790		306018UTFBW	1255		307218UTFBW	1368			
242418UTFBW	620																				
303018UTFBW	755																				
242424UTFBW	667																				
303024UTFBW	790																				
306018UTFBW	1255																				
307218UTFBW	1368																				

How to order?

_ 242418UTKWLCHR, Color: Whisky

Serie, Product, Wood color

UTILITY TABLES
KALYPSO

** Please refer to the Logiflex color chart **
for the choice of melamine color choices

Laminate	Wood
1"	1"
ML	KL

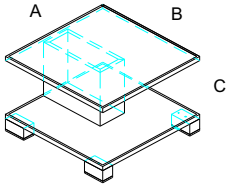
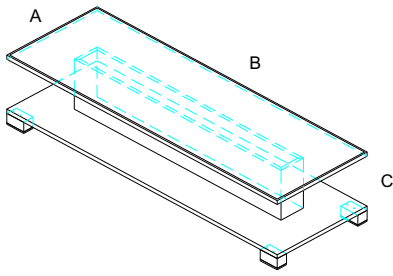
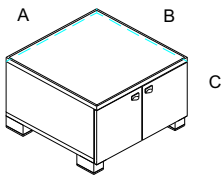
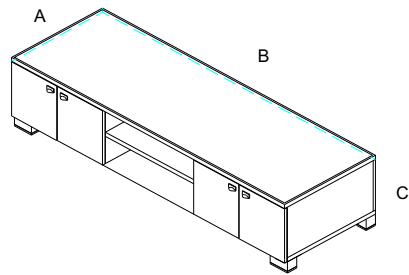
DESCRIPTION	PRODUCT	RETAIL PRICE	
	A B C		
Utility table and legs with chrome metal plate.			
	242418UTKWLCHR	—	831
	306018UTKWLCHR	—	1051
Utility table with doors and legs with chrome metal plate.			
	242418UTPKWLCHR	660	1 210
	246018UTPKWLCHR	990	2 035

logiflex Vol. 2

1235, St-Roch N., Sherbrooke (Quebec) Canada J1N 0H2



1 877 864-9323

1 800 474-7830

www.logiflex.ca
Printed in Canada