

LogiLife



PRICE LIST
2009

logiflex
July 2011 Update
Canada

TABLE OF CONTENTS

| | | |
|--------------------------------|------------------|---------|
| Terms of sale | | 2 -3 |
| General specifications | | 4 - 6 |
| Product map: | | |
| bedside cabinets | SIN 71-315 | 7 |
| dressers | SIN 71-315 | 8 |
| hutches | SIN 71-315 | 9 |
| wardrobe cabinets | SIN 71-315 | 10 - 13 |
| audio-visual units | SIN 71-315 | 14 - 15 |
| activity units | SIN 71-315 | 16 |
| How to order? | SIN 71-315 | 17 - 18 |
| Bedside Cabinets | SIN 71-315 | 19 - 20 |
| Dressers | SIN 71-315 | 21 - 22 |
| Hutches | SIN 71-315 | 23 - 24 |
| Wardrobe cabinets | SIN 71-315 | 25 - 28 |
| Headboards | SIN 71-315 | 29 |
| Footboards | SIN 71-315 | 29 |
| Audio-visual units | SIN 71-315 | 30 - 31 |
| Activity units | SIN 71-315 | 32 |
| Square and round tables | SIN 71-315 | 33 |
| Arc tables | SIN 71-315 | 34 |

TERMS OF SALE

Prices

The prices are "suggested retail" and are subject to changes without notice.

Terms of payment

Net 30 days, F.O.B. Deauville (Qc), Montreal and Quebec City. The invoice will be dated the same ship date and payable 30 days from that date including applicable freight charges.

Regular shipments

Please inquire about our lead time to customer service. Additional freight delays to the USA, to Western and Eastern provinces must be taken into consideration.

Orders

All orders are subject to acceptance by LOGIFLEX Inc. Please use our codes and clearly indicate the desired finishes.

Returns

Merchandise may not be returned without our previous written consent. A restocking charge of 25% will be charged in addition to any other expenses incurred to reinstate the unit into "new" condition. Shipment returned to us must be "freight prepaid".

Cancellations

All orders are considered firm and are not subject to cancellation without our approval. Cancellation charges may apply based upon incurred expenses in processing the order.

Liability

Our liability ends when the carrier issues us a clear receipt, acknowledging that the shipment has been received in good condition.

Claims

We strongly suggest that the shipment is carefully examined before you give a receipt to the carrier. All incomplete or damaged shipments should be refused. A claim for concealed damages must be filed with the carrier within 10 days of the delivery.

Storage charges

Upon request and with an established ship date, the merchandise can be stored for a maximum of 10 days against an adequate reimbursement.

TERMS OF SALE

Freight charges

All prices contained herein are suggested retail prices – F.O.B. factory, Deauville (Qc), Canada. Any and all freight conditions or arrangements other than above must be authorized in writing by LOGIFLEX and will be limited to conditions agreed upon. Deliveries to be forwarded to the dealer / distributor store or warehouse only.

Shipments with requested delivery other than above are subject to an extra fee as charged by the carrier.

Any delay at your docking facility could also call for an extra fee for which you could be requested to pay directly to the carrier.

Changes

LOGIFLEX reserves the right to institute changes in regards to materials, equipment, specifications and designs, as well as to discontinue models at any time without prior notice.

Ownership of goods

LOGIFLEX or its agents will retain full ownership of goods as listed until the full payment is totally remitted. Since all goods must be ordered by an official numbered and dated purchase order detailing the agreed terms and other pertinent details, the dealer / distributor agrees to above conditions and will be responsible in a court of law for all expenses incurred by LOGIFLEX to recover amounts due. This is understood as being part of buying conditions.

Warranty

LOGIFLEX guarantees its products for 10 years from the date of purchase. This warranty is valid only through the original dealer / distributor. Warranty covers faults or defects resulting from normal use of product and is limited to the repair or replacement of said product at **LOGIFLEX** discretion. Unauthorized repairs or abusive use will automatically void the warranty. All pieces of furniture are inspected and verified at shipping time. Any breakage at delivery time should be reported to the carrier or its agent for damage claim at DESTINATION POINT. **LOGIFLEX** cannot be held responsible for incidental or consequential damages in using its products.

Specific warranties

Polystyrene basket (plastic tray) - Product guaranteed for a period of three years from the date of purchase. This warranty is valid only through the original authorized dealer or distributor. Warranty covers faults or defects resulting from normal use of the product and is limited to the repair or replacement of said product at **LOGIFLEX** discretion.

Pneumatic base – Product guaranteed for a period of five years from the date of purchase. This warranty is valid only through the original authorized dealer or distributor. Warranty covers faults or defects resulting from normal use of the product and is limited to the repair or replacement of said product at **LOGIFLEX** discretion.

General Specifications

Structural Assembly

Doors and drawer fronts are installed over recessed sides. Locks can be added as an option, and will be factory installed on doors and drawer fronts (see specific price list pages for applicability). Each unit is self-supporting, and rests on 6" metal or wooden legs. Most parts are assembled with metal assembly fittings and dowels (cam sets), which are covered with color matching PVC cover caps.

Finishes

Tops - Standard

LF finish (1") Melamine: High density 1" particle board (42 to 45 lbs / po²), 2.5mm polyvinyl chloride (PVC) edge finishing (sealed joints – resistant and durable).

LFL finish (1-1/16") Laminate: High density 1" particle board (42 to 45 lbs / po²), top laminate sheet 1/32", bottom compensation sheet 1/32" (prevents bending), 2.5mm polyvinyl chloride (PVC) edge finishing (sealed joints – resistant and durable).

Tops - Custom-made

LFM finish (15/16") Linoleum: High density 3/4" particle board (42 to 45 lbs / po²), top and bottom 1/16" compensation sheets (prevents bending), 1/8" linoleum sheet (antibacterial quality), 2.5mm polyvinyl chloride (PVC) edge finishing (sealed joints – resistant and durable).

NOTE: PRICE ON REQUEST PER CASE BY QUOTATION DEPARTMENT

Bow Front Option (CX)

Adding CX option will result in a 1-1/2" bow front on all pieces except for headboards and footboards. These pieces will result in a 3" bow front.

Frame

High density 1" particle board, 2.5mm polyvinyl chloride (PVC) edge finishing on visible ends, 0.5mm polyvinyl chloride (PVC) edge finishing on hidden ends.

Bottom and adjustable shelves

High density 1" particle board, 2.5mm polyvinyl chloride (PVC) edge finishing.

Adjustable shelves come with metal supports, which may be screwed into unit sides once adjusted. Upon request, these shelves may be built in LFM finish (price upon request per case by quotation department).

General Specifications

Drawers

All drawers are made of color matching high density 5/8" particle board (42 to 45 lbs / po²), 0.5mm polyvinyl chloride (PVC) edge finishing (sealed joints – resistant and durable).

Full extension Quadro slides



16", combination full extension drawer runner and locking system with ball bearing slides, capacity 150 lbs. (applicable for dressers and wardrobe cabinets).

Full extension ball bearing slides



16" or 20", full extension drawer runner, capacity 100 lbs, silent, drawer easy to remove and put back, zinc plated (applicable for bedside cabinets, audio-visual units and activity units).

Doors and drawer fronts

High density 5/8" particle board (42 to 45 lbs / po²), 2.5mm polyvinyl chloride (PVC) edge finishing on visible ends, 0.5mm polyvinyl chloride (PVC) edge finishing on hidden ends (sealed joints – resistant and durable).

Hinges

Standard spring hinges, opening angle 110°, nickel plated steel.

Handles



Satin nickel **H130** handle used for bedside cabinets and hutches (drawer fronts and doors are pre-drilled at 128mm c/c).



Satin nickel **H160** handle used for all other applications (drawer fronts and doors are pre-drilled at 160mm c/c).

Handles positioned horizontally on drawer fronts, vertically on doors. Height of handles follows Logiflex standards. Upon request, door handles can be installed horizontally to accommodate specific ergonomic needs.

Locks

Satin nickel locks are available optionally on all Logilife furniture (see details, pages 19 to 28). Two keys are provided per lock, and one master lock is provided per order. Upon request, locks can be keyed alike. If not requested, locks will have random multiple key. Repetition of numbers can occur for orders of more than 50 units.

General Specifications

Dimensions

Dimensions and dimension codes are nominal. For side by side units, it is primordial you consider finished unit width will exceed nominal dimension code by 1/32".

Dimensions expressed in product maps are precise to the 1/8" near.

Custom-made units

A draft and all pertinent details must be submitted to our quotations department. A quotation including specifications and illustrations must be referred to when placing order.

Orders of custom-made units cannot be cancelled nor returned.

Packing

All units are assembled in factory and packed with protective corners and plastic film. Packing has been tested and complies with industry of transport standards.

Legs



OVAMSN: **Standard leg.** Satin nickel oval metal leg on leveler, 6" high, 16 GA steel 1-9/16" x 3-3/16" tube, 3-1/2" x 4" x 1/8" steel plate. Glued and screwed in under bottom of unit.



OVAMWFSN: Satin nickel oval metal leg on caster with break, 6" high, 16 GA steel 1-9/16" x 3-3/16" tube, 3-1/2" x 4" x 1/8" steel plate. Glued and screwed in under bottom of unit (compatible for bedside cabinets only).

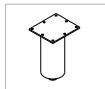

IFMNSN: Satin nickel tube metal leg on leveler, 6" high, 16 GA steel, 2-1/2" diam. tube, 3-1/2" x 4" x 1/8" steel plate. Glued and screwed in under bottom of unit.



IFMWFSN: Satin nickel tube metal leg on caster with break, 6" high, 16 GA steel, 2-1/2" diam. tube, 3-1/2" x 4" x 1/8" steel plate. Glued and screwed in under bottom of unit (compatible with bedside cabinets only).

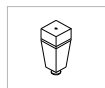

WL2: Wooden leg on leveler, 6" high, 2-1/4" x 2-1/4", available in all Logiflex color chart wood finishes. Glued and screwed in under bottom of unit (compatible with bedside cabinets only).

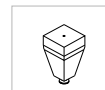

WL3: Wooden leg on leveler, 6" high, 3" x 3", available in all Logiflex color chart wood finishes. Glued and screwed in under bottom of unit.

**PRODUCT MAP
BEDSIDE CABINETS**

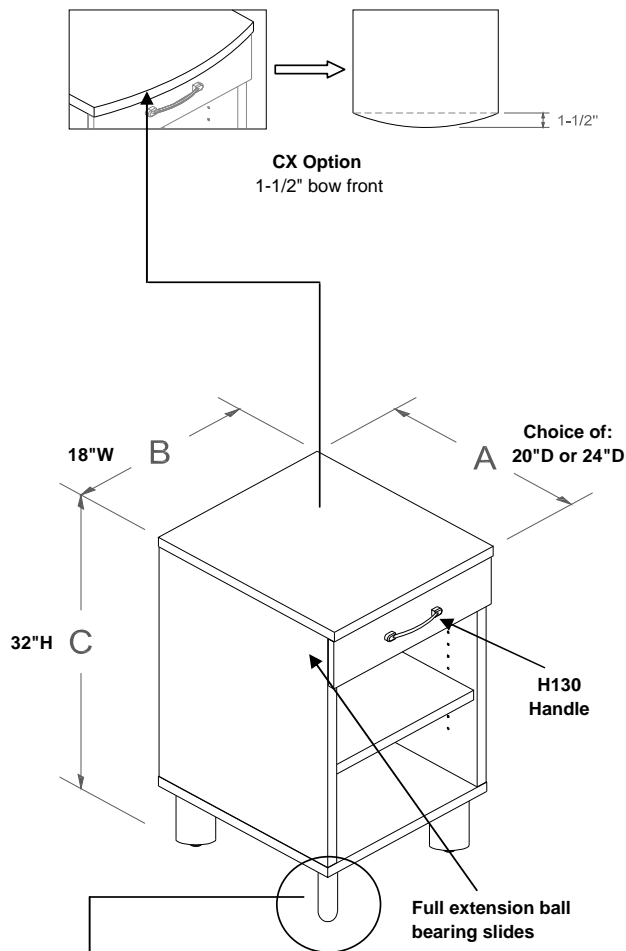

D = Depth, W = Width, H = Height

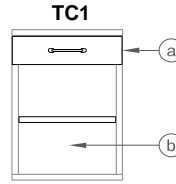

- TC1**
- a) Drawer front exterior dimension:
17-7/8"W x 4-7/8"H
 - Drawer interior dimension:
20"D = 14-3/4"D x 13-5/8"W x 2-3/8"H
24"D = 18-3/4"D x 13-5/8"W x 2-3/8"H

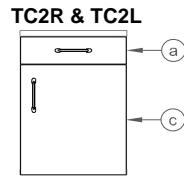

- b) Open space interior dimension:
20"D = 18-3/8"D x 15-7/8"W x 19"H
24"D = 22-3/8"D x 15-7/8"W x 19"H
- c) Door front exterior dimension:
17-7/8"W x 19-7/8"H
- Door interior dimension:
20"D = 18-3/8"D x 15-7/8"W x 19"H
24"D = 22-3/8"D x 15-7/8"W x 19"H

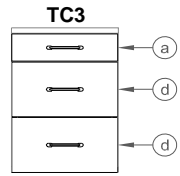

- d) Drawer front exterior dimension:
17-7/8"W x 9-7/8"H
- Drawer interior dimension:
20"D = 14-3/4"D x 13-5/8"W x 7"H
24"D = 18-3/4"D x 13-5/8"W x 7"H

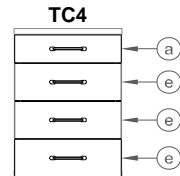

- e) Drawer front exterior dimension:
17-7/8"W x 6-5/8"H
- Drawer interior dimension:
20"D = 14-3/4"D x 13-5/8"W x 3-3/8"H
24"D = 18-3/4"D x 13-5/8"W x 3-3/8"H

- TC1 = 1 drawer front lock.
- TC2 = 1 drawer front lock and
1 cabinet door lock.
- TC3 = 1 drawer front lock.
- TC4 = 1 drawer front lock.

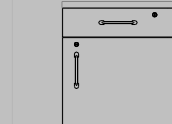

Lock option

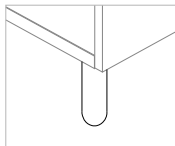

OVAMSN
(standard)
Oval metal leg on
leveler, 6" high,
1-9/16" x 3-3/16" tube

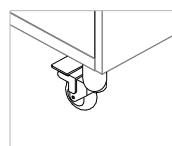

OVAMWFSN
Oval metal leg on caster
with break, 6" high, 1-9/16"
x 3-3/16" tube

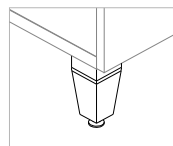

WL2
Wooden leg on
leveler, 6"
high, 2-1/4" x 2-
1/4"

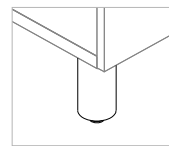

IFMNSN
Metal leg on
leveler, 6" high, 2-
1/2" diam. tube

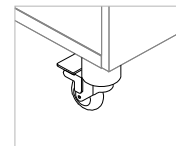

IFMWFSN
Metal leg on caster with
break, 6" high, 2-
1/2" diam. tube

**PRODUCT MAP
DRESSERS**

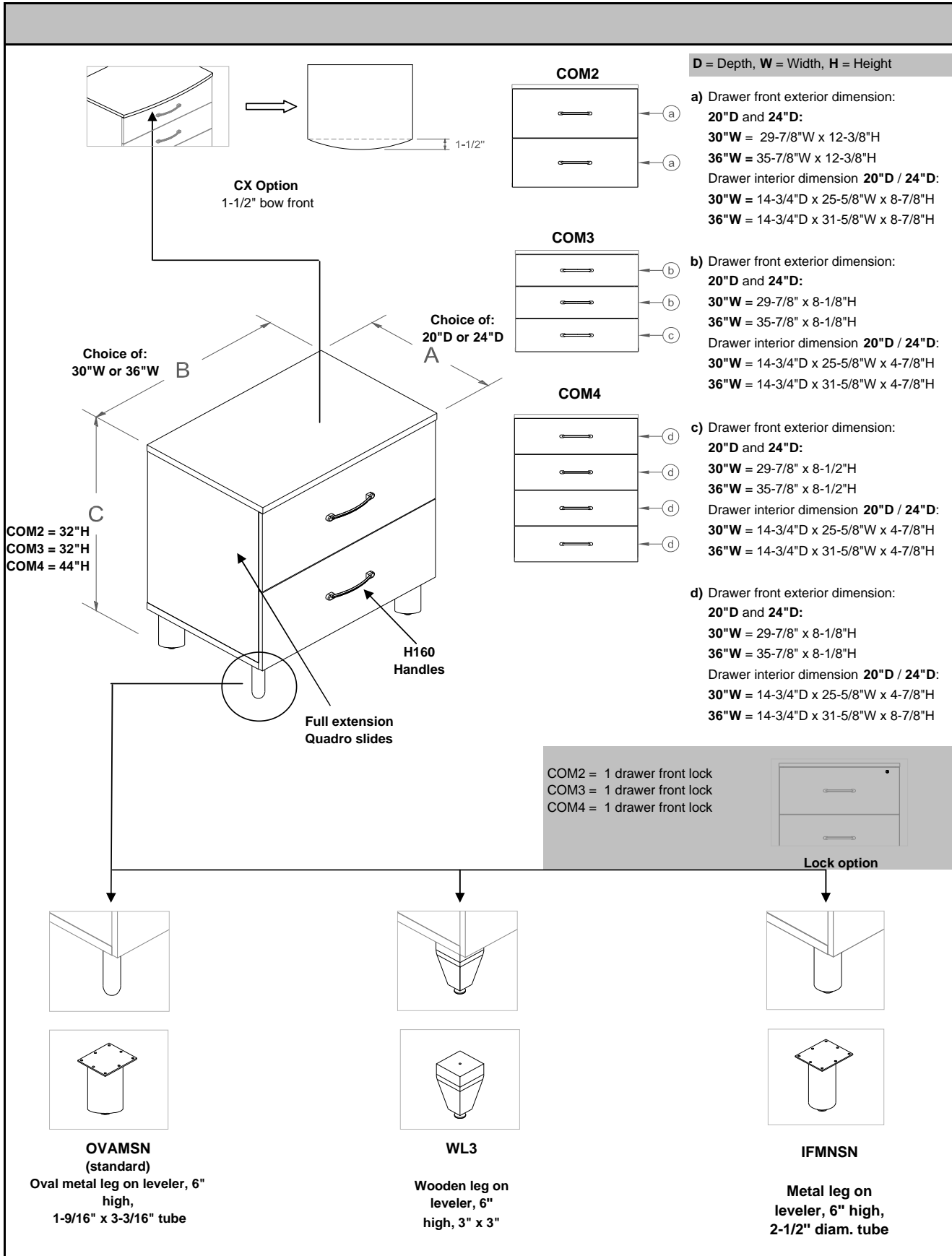

**PRODUCT MAP
HUTCHES**

CX Option
1-1/2" bow front

Anti-Tipping Kit

Choice of:
30"W or 36"W

A 16"D

B

C

H130 Handles

HL28 = 28"H
HLA40 = 40"H
HLA52 = 52"H

HL28

HLA40

HLA52

D = Depth, W = Width, H = Height

a) Door front exterior dimension:
30"W = 14-7/8"W x 13-7/8"H
36"W = 17-7/8"W x 13-7/8"H
Door interior dimension:
30"W = 14-3/8"D x 28"W x 13"H
36"W = 14-3/8"D x 34"W x 13"H

b) Open space interior dimension:
30"W = 14-3/8"D x 28"W x 13"H
36"W = 14-3/8"D x 34"W x 13"H

c) Open space interior dimension:
30"W = 14-3/8"D x 28"W x 25"H
36"W = 14-3/8"D x 34"W x 25"H

d) Open space interior dimension:
30"W = 14-3/8"D x 28"W x 37"H
36"W = 14-3/8"D x 34"W x 37"H

HL28 = 1 door front lock
HL40 = 1 door front lock
HLA52 = 1 door front lock

Lock option

Lock option

Horizontal handle option
Pricing upon request only

Extra adjustable shelves option
for HLA hutches

Anti-tipping kit mandatory for hutches.

**** a minimum of 2 sets is necessary ****

*** Logiflex is not liable for any breakage *
if this directive is not followed.**

**PRODUCT MAP
WARDROBE CABINETS**

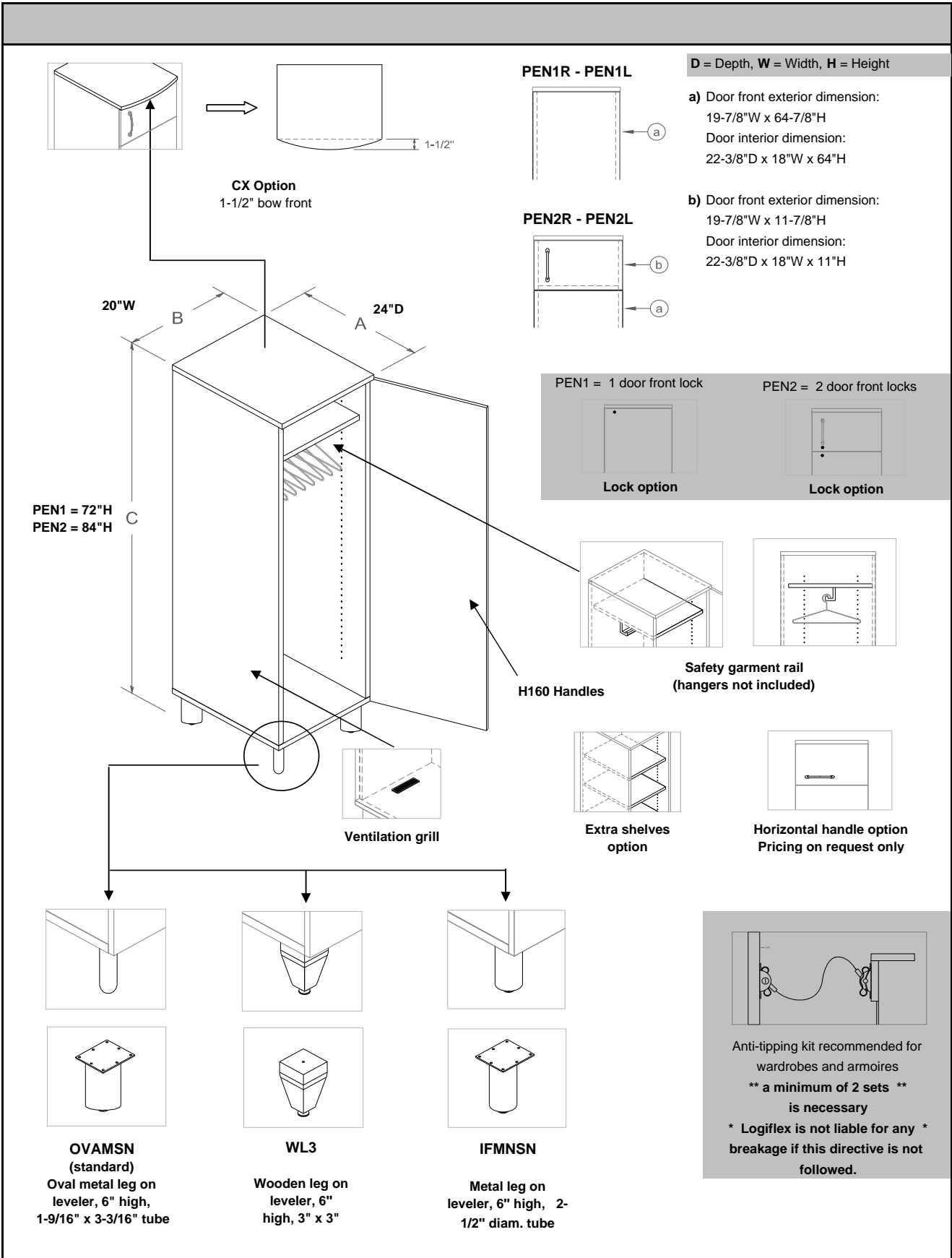

**PRODUCT MAP
WARDROBE CABINETS**

D = Depth, W = Width, H = Height

CX Option
1-1/2" bow front

Choice of : 30"W, 36"W or 42"W

A 24"D

B

C
PEN3 = 72"H
PEN5 = 84"H

PEN3

a) Door front exterior dimension:
 30"W = (2x) 14-7/8"W x 64-7/8"H
 36"W = (2x) 17-7/8"W x 64-7/8"H
 42"W = (2x) 20-7/8"W x 64-7/8"H
 Door interior dimension:
 30"W = 22-3/8"D x 28"W x 64"H
 36"W = 22-3/8"D x 34"W x 64"H
 42"W = 22-3/8"D x 40"W x 64"H

PEN5

b) Door front exterior dimension:
 30"W = (2x) 14-7/8"W x 11-7/8"H
 36"W = (2x) 17-7/8"W x 11-7/8"H
 42"W = (2x) 20-7/8"W x 11-7/8"H
 Door interior dimension:
 30"W = 22-3/8"D x 28"W x 11"H
 36"W = 22-3/8"D x 34"W x 11"H
 42"W = 22-3/8"D x 40"W x 11"H

Armoires with folding doors

c) Door front exterior dimension:
 30"W = (4x) 7-3/8"W x 64-7/8"H
 36"W = (4x) 8-7/8"W x 64-7/8"H

**** Available only for units ****
30" W and 36"W.

H160 Handles

Ventilation grill

Safety garment rail
(hangers not included)

PEN3 = 1 door front lock
 PEN5 = 2 door front locks

PEN3 = 1 door front lock
 PEN5 = 2 door front locks

Lock option

Lock option Folding doors

Extra shelves option

Horizontal handle option
 Pricing upon request only

OVAMSN (standard)
 Oval metal leg on leveler, 6" high, 1-9/16" x 3-3/16" tube

WL3
 Wooden leg on leveler, 6" high, 3" x 3"

IFMNSN
 Metal leg on leveler, 6" high, 2-1/2" diam. tube

Anti-tipping kit recommended for wardrobes and armoires
**** a minimum of 2 sets ** is necessary**
*** Logiflex is not liable for any breakage if this directive is not followed.**

**PRODUCT MAP
WARDROBE CABINETS**

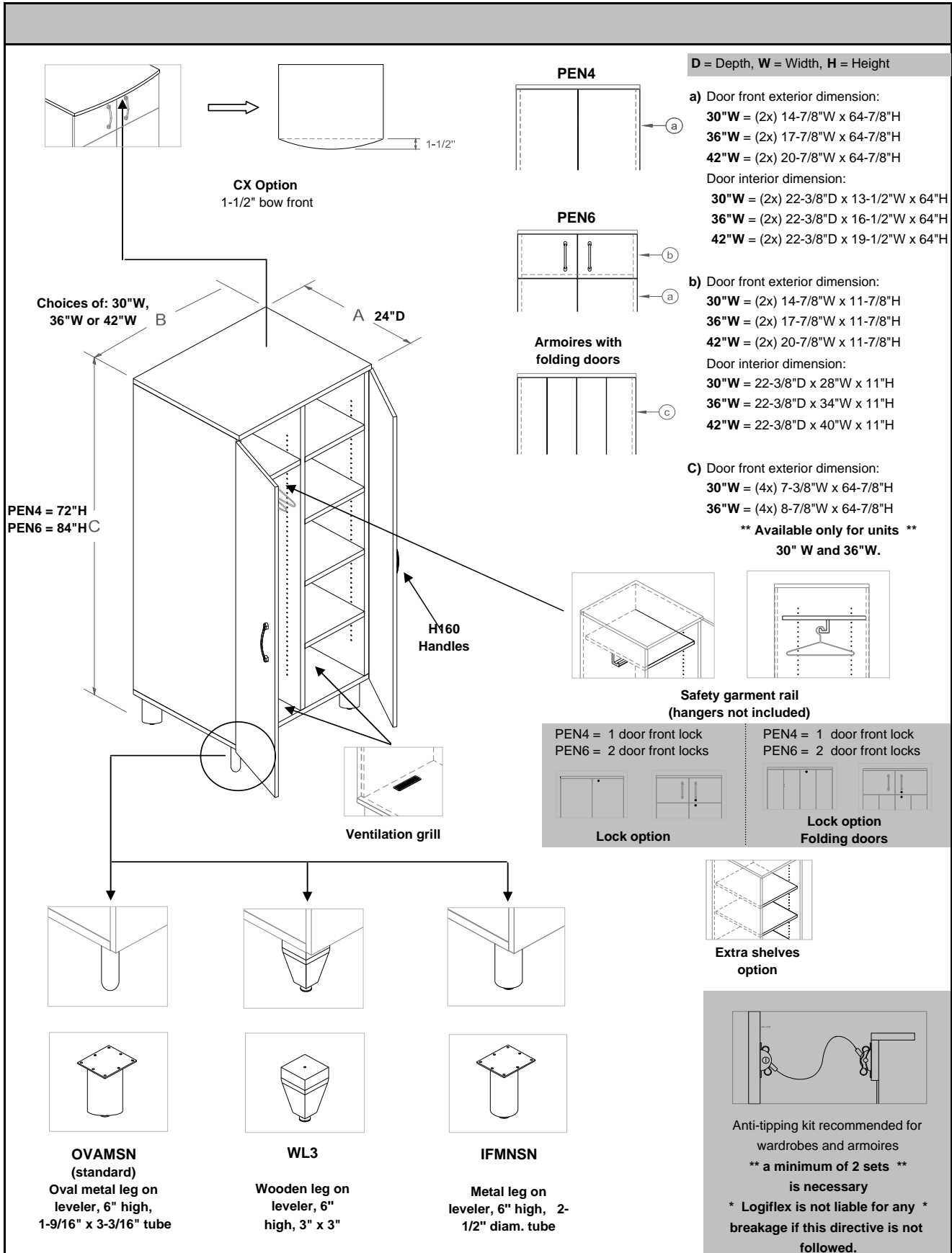

**PRODUCT MAP
WARDROBE CABINETS**

D = Depth, W = Width, H = Height

PEN7

a) Door front exterior dimension:
42\"W = 12-7/8\"W x 64-7/8\"H
48\"W = 18-7/8\"W x 64-7/8\"H
 Door interior dimension:
42\"W = 22-3/8\"D x 11\"W x 64\"H
48\"W = 22-3/8\"D x 17\"W x 64\"H

b) Open space dimension:
 22-3/8\"D x 28\"W x 39-1/4\"H

PEN8

c) Drawer front exterior dimension:
 28-7/8\"W x 9-1/4\"H
 Drawer interior dimension :
 14-3/4\"D x 25-5/8\"W x 4-7/8\"H

d) Drawer front exterior dimension:
 28-7/8\"W x 8-1/8\"H
 Drawer interior dimension :
 14-3/4\"D x 25-5/8\"W x 4-7/8\"H

e) Door front exterior dimension:
42\"W = 12-7/8\"W x 11-7/8\"H
48\"W = 18-7/8\"W x 11-7/8\"H
 Door interior dimension:
42\"W = 22-3/8\"D x 11\"W x 11\"H
48\"W = 22-3/8\"D x 17\"W x 11\"H

f) Open space dimension:
 22-3/8\"D x 28\"W x 51-1/4\"H

OVAMSN (standard)
 Oval metal leg on leveler, 6\" high, 1-9/16\" x 3-3/16\" tube

WL3
 Wooden leg on leveler, 6\" high, 3\" x 3\"

IFMNSN
 Metal leg on leveler, 6\" high, 2-1/2\" diam. tube

Anti-tipping kit recommended for wardrobes and armoires
**** a minimum of 2 sets ** is necessary**
*** Logiflex is not liable for any * breakage if this directive is not followed.**

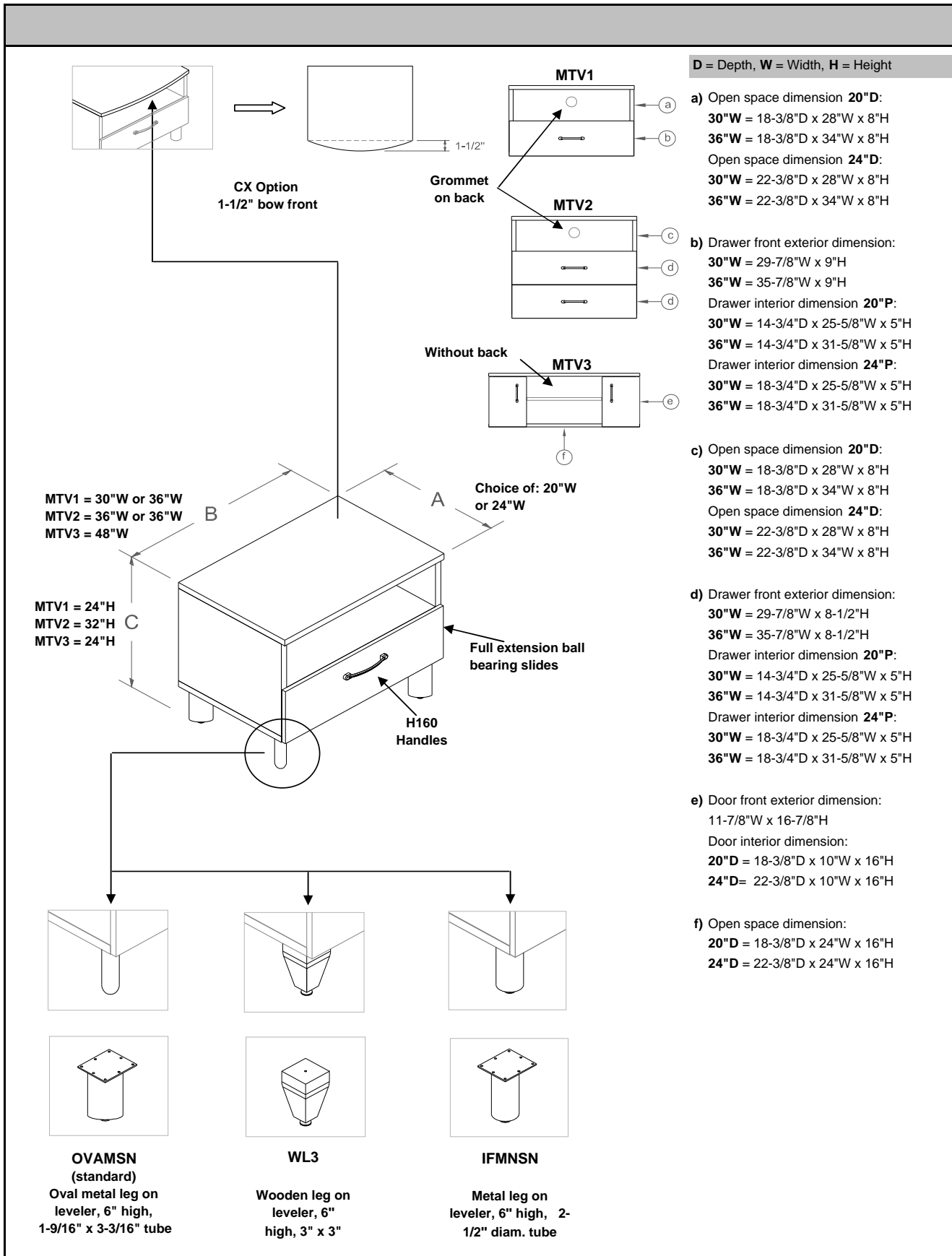

**PRODUCT MAP
AUDIO-VISUAL UNITS**

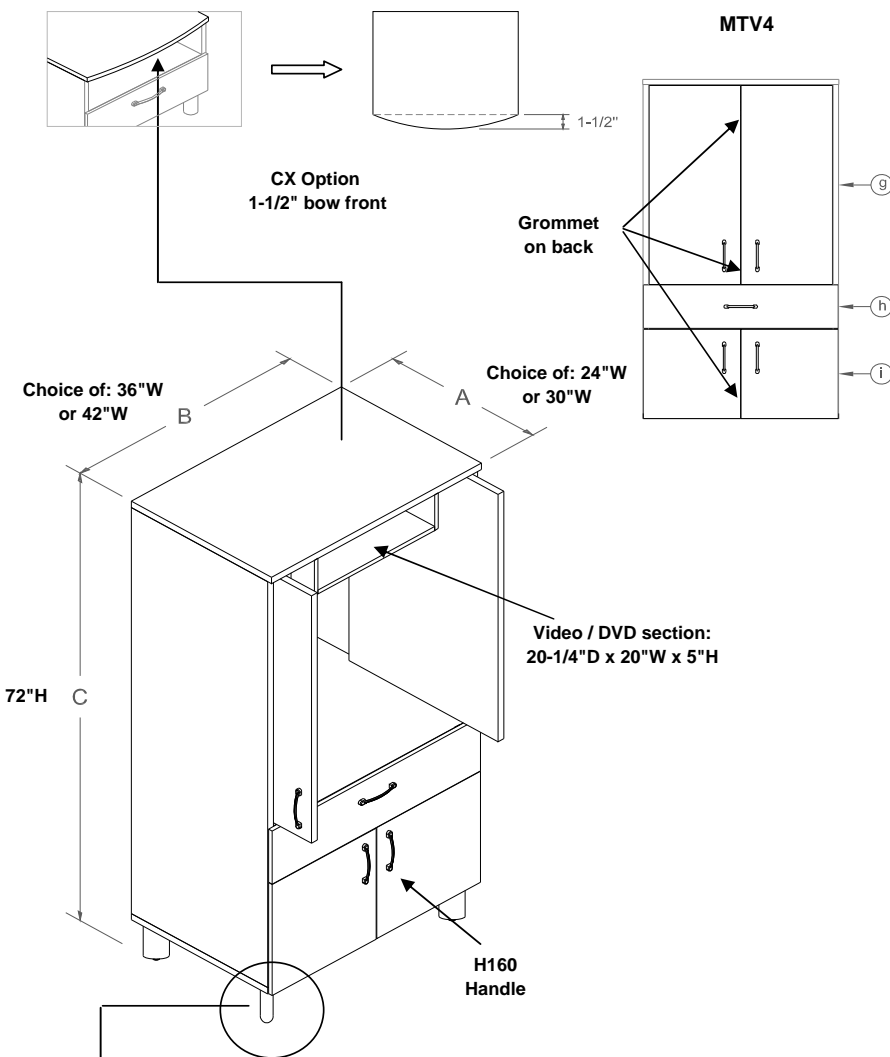

D = Depth, W = Width, H = Height

- g) Door front exterior dimension:**
 36"W = (2x) 16-13/16"W x 38-3/4"H
 42"W = (2x) 19-13/16"W x 38-3/4"H
 Door interior dimension **24"D**:
 36"W = 22-3/8"D x 30"W x 39"H
 42"W = 22-3/8"D x 36"W x 39"H
 Door interior dimension **30"D**:
 36"W = 28-3/8"D x 30"W x 39"H
 42"W = 28-3/8"D x 36"W x 39"H

- h) Drawer front exterior dimension:**
 36"W = 35-7/8"W x 8-1/2"H
 42"W = 41-7/8"W x 8-1/2"H
 Drawer interior dimension **20"D**:
 36"W = 18-3/4"D x 31-5/8"W x 5"H
 42"W = 18-3/4"D x 37-5/8"W x 5"H
 Drawer interior dimension **24"D**:
 36"W = 18-3/4"D x 31-5/8"W x 5"H
 42"W = 18-3/4"D x 37-5/8"W x 5"H

- i) Door front exterior dimension:**
 36"W = (2x) 17-7/8"W x 17-3/8"H
 42"W = (2x) 20-7/8"W x 17-3/8"H
 Door interior dimension **24"D**:
 36"W = 22-3/8"D x 34"W x 16-1/2"H
 42"W = 22-3/8"D x 40"W x 16-1/2"H
 Door interior dimension **30"D**:
 36"W = 28-3/8"D x 34"W x 16-1/2"H
 42"W = 28-3/8"D x 40"W x 16-1/2"H

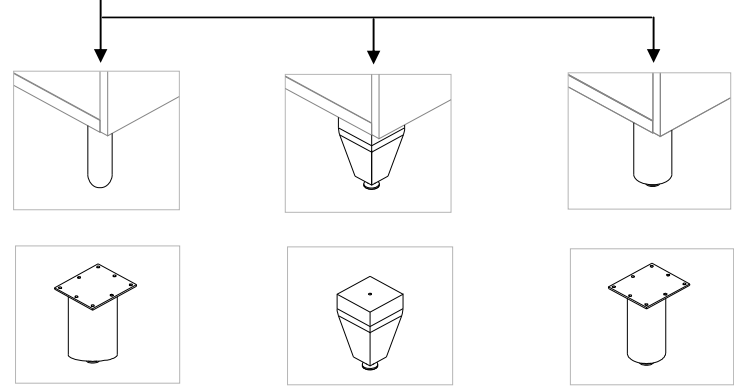

OVAMSN
(standard)
Oval metal leg on leveler, 6" high, 1-9/16" x 3-3/16" tube

WL3
Wooden leg on leveler, 6" high, 3" x 3"

IFMNSN
Metal leg on leveler, 6" high, 2-1/2" diam. tube

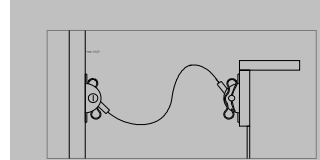

Anti-tipping kit recommended for audio-visual units

**** a minimum of 2 sets **
is necessary**
* Logiflex is not liable for any *
breakage if this directive is not followed.

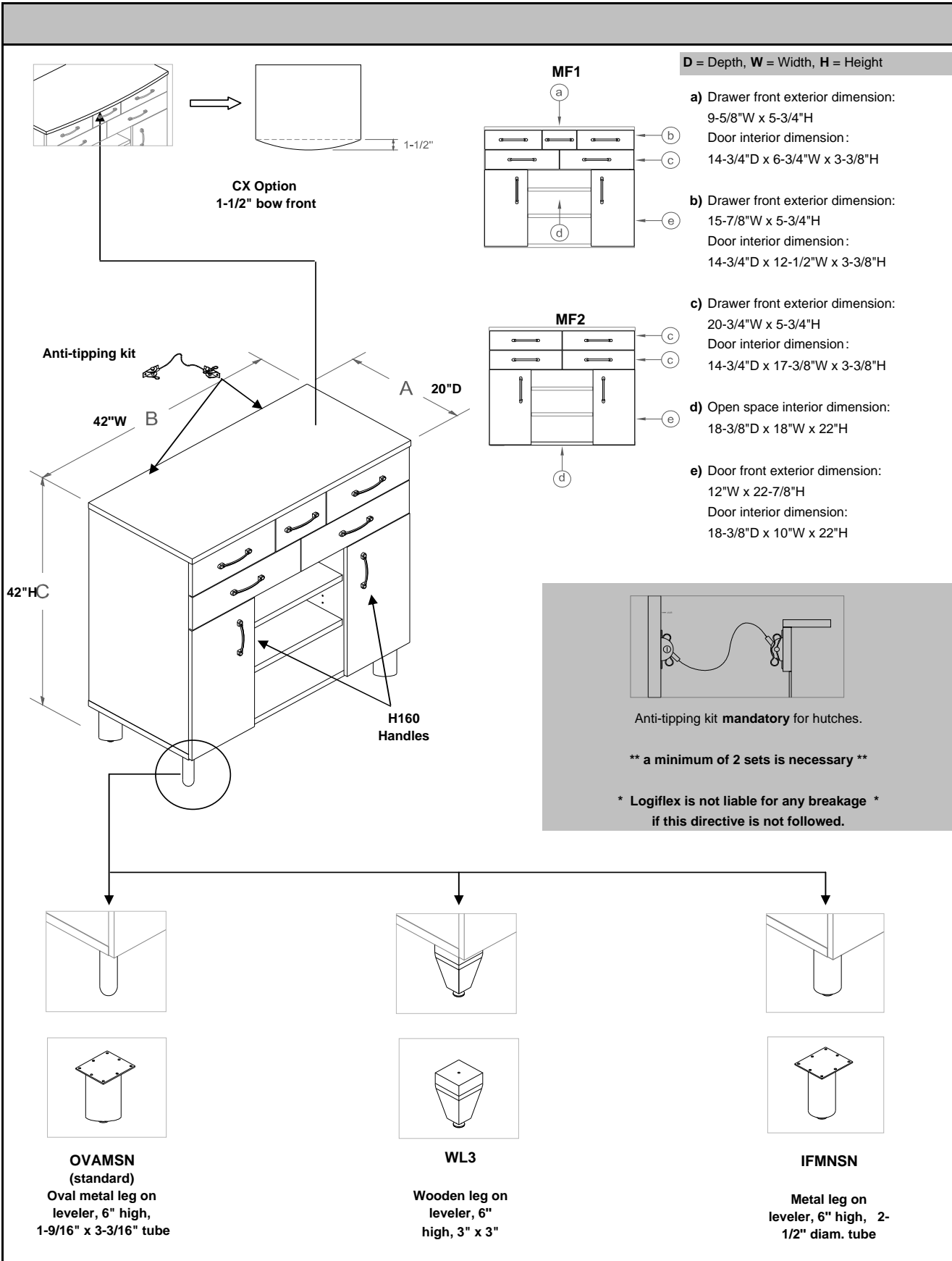

HOW TO ORDER?

SIN 71-315

| Component selection | | | | | | | | | | | | | | | | | | |
|---|------|------------------------|--|------------------------------|------------------|--|---------------------------------|------|------------------------------------|------|--|------|-----------------------------|------|--|---------|----|---------|
| Complete code without options: LF-201832TC1OVAMSN | | | | | | | | | | | | | | | | | | |
| Complete code with options: LF-201832TC1CXOVAMWFSNLKSNINS | | | | | | | | | | | | | | | | | | |
| | | LF | 20 | 18 | 32 | | | TC1 | CX | | | | OVAM | WF | | | SN | LKSNINS |
| | | ↑ | ↑ | ↑ | ↑ | | | ↑ | ↑ | | | | ↑ | ↑ | | | ↑ | ↑ |
| Top finishes | Code | Depth | Width | Height | Product | Code | OPTION | Code | Legs | Code | OPTIONS | Code | Leg finish | Code | OPTION | Code | | |
| Melamine 1" | LF | Bedside cabinet 20 | Bedside cabinet 18 | Bedside cabinet 32 | Bedside cabinet | TC1 TC2R TC2L | Bow front | CX | Oval metal leg | OVAM | Caster with break option for OVAM and IFMN legs only | WF | Satin Nickel for metal legs | SN | Lock option, Satin Nickel, factory installed | LKSNINS | | |
| Laminate 1" | LFL | 24 | | | | TC3 TC4 | Folding doors for armoires only | FD | Wooden leg for bedside cabinets | WL2 | | | | | | | | |
| | | Dresser 20 24 | Dresser 30 36 | Dresser 32 44 | Dresser | COM2 COM3 COM4 | | | Wooden leg for all other furniture | WL3 | | | | | | | | |
| | | Hutch 16 | Hutch 30 36 | Hutch 28 40 52 | Hutch | HL28 HLA40 HLA52 | | | Tubular metal leg | IFMN | | | | | | | | |
| | | Wardrobe Armoire 24 | Wardrobe Armoire 20 30 36 42 48 | Wardrobe Armoire 72 84 | Wardrobe Armoire | PEN1R PEN1L PEN2R PEN2L PEN3 PEN4 PEN5 PEN6 PEN7 PEN8 | | | Pneumatic base | BPX | | | | | | | | |
| | | | Headboard 39 | Headboard 22 25 | Headboard | TLRT TLCX | | | | | | | | | | | | |
| | | | Footboard 39 | Footboard 16 19 | Footboard | PLRT PLCX | | | | | | | | | | | | |

HOW TO ORDER?

SIN 71-315

18

| Component selection | | | | | | | | | | | | | | | | |
|---|------|--------------------|--------------------|--------------------|--------------------|------------------------------|--------|------|----------------|---------|---------|------|------------|------|--------|------|
| Complete code without options: LF-201832TC1OVAMSN | | | | | | | | | | | | | | | | |
| Complete code with options: LF-201832TC1CXOVAMWFSNLKSNINS | | | | | | | | | | | | | | | | |
| | LF | 20 | 18 | 32 | TC1 | CX | OVAM | WF | SN | LKSNINS | | | | | | |
| Top finishes | Code | Depth | Width | Height | Product | Code | OPTION | Code | Legs | Code | OPTIONS | Code | Leg finish | Code | OPTION | Code |
| | | Audio-visual units | Audio-visual units | Audio-visual units | Audio-visual units | MTV1 MTV2 MTV3 MTV4 | | | | | | | | | | |
| | | 20 | 30 | 24 | | | | | | | | | | | | |
| | | 24 | 36 | 32 | | | | | | | | | | | | |
| | | 30 | 42 | 72 | | | | | | | | | | | | |
| | | | 48 | | | | | | | | | | | | | |
| | | Activity units | Activity units | Activity units | Activity units | MF1 MF2 | | | | | | | | | | |
| | | 20 | 42 | 42 | | | | | | | | | | | | |
| | | Arc table | Arc table | | Arc table | ARC9 ARC10 ARC12 | | | Pneumatic base | BPX | | | | | | |
| | | 38 | 42 | | | | | | | | | | | | | |
| | | 42 | 48 | | | | | | | | | | | | | |
| | | 48 | | | | | | | | | | | | | | |
| | | Square table | Square table | | Square table | TC | | | | | | | | | | |
| | | 38 | 38 | | | | | | | | | | | | | |
| | | 36 | 36 | | | | | | | | | | | | | |
| | | 42 | 42 | | | | | | | | | | | | | |
| | | Round table | Round table | | Round table | TR | | | | | | | | | | |
| | | 38 | 38 | | | | | | | | | | | | | |
| | | 36 | 36 | | | | | | | | | | | | | |
| | | 42 | 42 | | | | | | | | | | | | | |

(CONT)

LF = Melamine top and frame

LFL = Laminate top and melamine frame



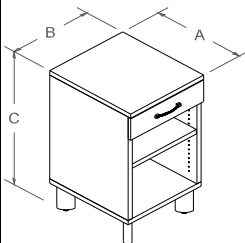
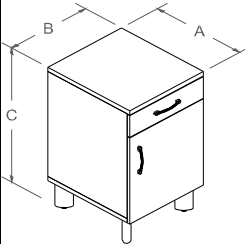

How to order?
 _ 201832TC1OVAMSN
 (LF / LFL)

BEDSIDE CABINETS

**** LFM = Linoleum top and melamine base (pricing upon request only).****
**** Pricing may vary depending on volume, please specify requested quantities ****

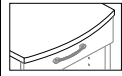
| | DESCRIPTION | PRODUCTS | FINISHES | | |
|---|-------------|--------------------------------------|----------|-------------|--|
| | | | melamine | laminata | |
| | | | 1" LF | 1-1/16" LFL | |
|  <p>TC1 Bedside cabinet, including: - 1 drawer with full extension slides; - 1 satin nickel H130 handle for drawer; - 19"H open section for storage with one adjustable shelf; - 4 satin nickel oval metal legs on levelers.</p> | 20" deep | 201832TC1OVAMSN | 609 | 635 | |
| | 24" deep | 241832TC1OVAMSN | 641 | 672 | |
| | | | | | |
| | | | | | |
|  <p>TC2R and TC2L Bedside cabinet, including: - 1 drawer with full extension slides; - 1 satin nickel H130 handle for drawer and door; - 19"H open section with door for storage with one adjustable shelf and ventilation grill; - 4 satin nickel oval metal legs on levelers.</p> <p>"R" right side hinges "L" left side hinges</p> | 20" deep | 201832TC2ROVAMSN 201832TC2LOVAMSN | 677 | 704 | |
| | 24" deep | 241832TC2ROVAMSN 241832TC2LOVAMSN | 709 | 740 | |
| | | | | | |
| | | | | | |

OPTIONS

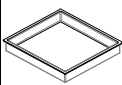
| | | |
|---|----------------|-----------|
|  <p>Bow front option 1-1/2"</p> | CX | 53 |
|  <p>Satin nickel lock, factory installed TC1 = 1 lock on drawer. TC2 = 1 lock on drawer, 1 lock on door.</p> | LKSNINS | 32 /ch. |
|  <p>Wooden leg 2-1/4" x 2-1/4" x 6"H on leveler (all Logiflex color chart wood finishes).</p> | WL2 | N/C |
|  <p>Tubular metal leg 2-1/2" diam. x 6"H on leveler.</p> | IFMNSN | N/C |
|  <p>Casters with stem and break, in translucent plastic (88 lbs charge per caster). (addition to OVAM and IFMN legs only) ** Please change leg codes for OVAMWFSN or IFMWFSN.**</p> | WF | 47 / ens. |
|  <p>White plastic basket, easy to clean (resistant to all care products), rounded corners for complete surface cleanup, easy to remove and put back into drawer.</p> | BP | 79 |

LF = Melamine top and frame

LFL = Laminate top and melamine frame



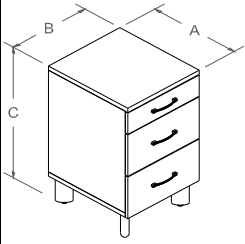
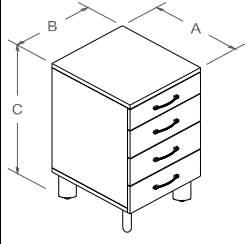

How to order?
 _ 201832TC3OVAMSN
 (LF / LFL)

BEDSIDE CABINETS

**** LFM = Linoleum top and melamine base (pricing upon request only).****
**** Pricing may vary depending on volume, please specify requested quantities ****

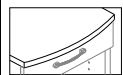
| | DESCRIPTION | PRODUCTS | FINISHES | |
|---|-------------|-----------------|----------|-------------|
| | | | melamine | laminate |
| | | | 1" LF | 1-1/16" LFL |
|  <p>TC3 Bedside cabinet, including: - 3 drawers with full extension slides; - 3 satin nickel H130 handle for drawers; - 4 satin nickel oval metal legs on levelers.</p> | | A B C | | |
| | 20" deep | 201832TC3OVAMSN | 782 | 809 |
| | 24" deep | 241832TC3OVAMSN | 814 | 845 |
| | | | | |
|  <p>TC4 Bedside cabinet, including: - 4 drawers with full extension slides; - 4 satin nickel H130 handle for drawers; - 4 satin nickel oval metal legs on levelers.</p> | | | | |
| | 20" deep | 201832TC4OVAMSN | 845 | 872 |
| | 24" deep | 241832TC4OVAMSN | 877 | 908 |
| | | | | |

OPTIONS

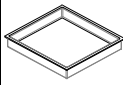
| | | |
|---|----------------|-----------|
|  <p>Bow front option 1-1/2"</p> | CX | 53 |
|  <p>Satin nickel lock, factory installed TC3 = 1 lock on drawer. TC4 = 1 lock on drawer.</p> | LKSNINS | 32 /ch. |
|  <p>Wooden leg 2-1/4" x 2-1/4" x 6"H on leveler (all Logiflex color chart wood finishes).</p> | WL2 | N/C |
|  <p>Tubular metal leg 2-1/2" diam. x 6"H on leveler.</p> | IFMNSN | N/C |
|  <p>Casters with stem and break, in translucent plastic (88 lbs charge per caster). (addition to OVAM and IFMN legs only) ** Please change leg codes for OVAMWFSN or IFMWFSN.**</p> | WF | 47 / ens. |
|  <p>White plastic basket, easy to clean (resistant to all care products), rounded corners for complete surface cleanup, easy to remove and put back into drawer.</p> | BP | 79 |

LF = Melamine top and frame
 LFL = Laminate top and melamine frame

How to order?
 _ 203032COM2OVAMSN
 (LF / LFL)

**** LFM = Linoleum top and melamine base (pricing upon request only).****
**** Pricing may vary depending on volume, please specify requested quantities ****

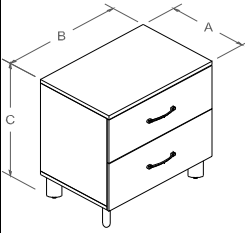
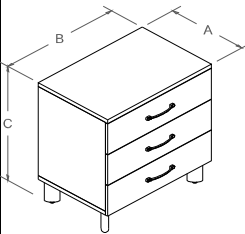
| | DESCRIPTION | PRODUCTS | FINISHES | | |
|---|---|------------------|------------------|----------------|------|
| | | | melamine | laminat | |
| | | | 1" LF | 1-1/16" LFL | |
|  <p>COM2 Dresser, including: - 2 drawers with full extension Quadro slides and Interlock system; - 2 satin nickel H160 handles for drawers; - 4 satin nickel oval metal legs on levelers.</p> | 20" deep | A B C | | | |
| | | 203032COM2OVAMSN | 898 | 940 | |
| | | | 203632COM2OVAMSN | 945 | 998 |
| | 24" deep | | 243032COM2OVAMSN | 945 | 998 |
| | | | 243632COM2OVAMSN | 992 | 1055 |
| |  <p>COM3 Dresser, including: - 3 drawers with full extension Quadro slides and Interlock system; - 3 satin nickel H160 handles for drawers; - 4 satin nickel oval metal legs on levelers.</p> | 20" deep | 203032COM3OVAMSN | 1055 | 1097 |
| | | | 203632COM3OVAMSN | 1103 | 1155 |
| 24" deep | | | 243032COM3OVAMSN | 1103 | 1155 |
| | | | 243632COM3OVAMSN | 1150 | 1213 |

OPTIONS

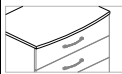

Bow front option 1-1/2"

| | |
|-----------|----|
| CX | 53 |
|-----------|----|



Satin nickel lock, factory installed
 COM2 = 1 lock on drawer (locks all drawers).
 COM3 = 1 lock on drawer (locks all drawers).

| | |
|----------------|---------|
| LKSNINS | 32 /ch. |
|----------------|---------|



Wooden leg 3" x 3" x 6"H on leveler (all Logiflex color chart wood finishes).

| | |
|------------|-----|
| WL3 | N/C |
|------------|-----|



Tubular metal leg 2-1/2" diam. x 6"H on leveler.

| | |
|---------------|-----|
| IFMNSN | N/C |
|---------------|-----|

**** Please change leg codes for WL3 or IFMNSN.****



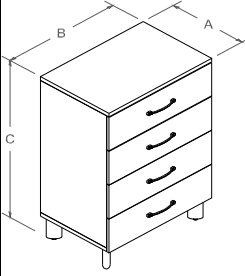

LF = Melamine top and frame
 LFL = Laminate top and melamine frame

How to order?
 _ 203044COM4OVAMSN
 (LF / LFL)

**** LFM = Linoleum top and melamine base (pricing upon request only).****
**** Pricing may vary depending on volume, please specify requested quantities ****

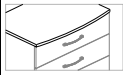
| | DESCRIPTION | PRODUCTS | FINISHES | |
|---|-----------------|-------------------------|----------|----------------|
| | | | melamine | laminata |
| | | | 1" LF | 1-1/16" LFL |
|  <p>COM4 Dresser, including: - 4 drawers with full extension Quadro slides and Interlock system; - 4 satin nickel H160 handles for drawers; - 4 satin nickel oval metal legs on levelers.</p> | | A B C | | |
| | 20" deep | 203044COM4OVAMSN | 1229 | 1271 |
| | | 203644COM4OVAMSN | 1276 | 1328 |
| | 24" deep | 243044COM4OVAMSN | 1276 | 1328 |
| | | 243644COM4OVAMSN | 1323 | 1386 |
| | | | | |

OPTIONS

| | | |
|---|----------------|---------|
|  <p>Bow front option 1-1/2"</p> | CX | 53 |
|  <p>Satin nickel lock, factory installed COM4 = 1 lock on drawer (locks all drawers).</p> | LKSNINS | 32 /ch. |
|  <p>Wooden leg 3" x 3" x 6"H on leveler (all Logiflex color chart wood finishes).</p> | WL3 | N/C |
|  <p>Tubular metal leg 2-1/2" diam. x 6"H on leveler.</p> <p>** Please change leg codes for WL3 or IFMNSN.**</p> | IFMNSN | N/C |

LF = Melamine top and frame
 LFL = Laminate top and melamine frame



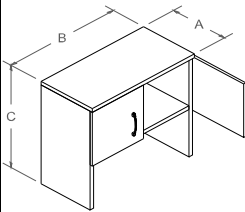
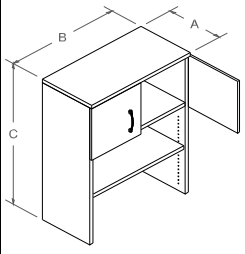

How to order?
 _ 1630HL28
 (LF / LFL)

CLOSED HUTCHES WITH HINGED DOORS

**** LFM = Linoleum top and melamine base (pricing upon request only). ****
**** Pricing may vary depending on volume, please specify requested quantities ****

| | DESCRIPTION | PRODUCTS | FINISHES | |
|---|-------------|------------------|----------|-------------|
| | | | melamine | laminate |
| | | | 1" LF | 1-1/16" LFL |
|  <p>HL 28"H hutch with doors, including: - 2 hinged doors; - 2 satin nickel H130 handles for doors; - 13"H open space inside doors; - Rubber wire cover cap on bottom.</p> | | A B C | | |
| | | 1630HL28 | 509 | — |
| | | 1636HL28 | 562 | — |
| | | | | |
|  <p>HLA 40"H hutch with doors, including: - 2 hinged doors; - 2 satin nickel H130 handles for doors; - 13"H open space inside doors; - 1 adjustable shelf; - Rubber wire cover cap on bottom.</p> | | 1630HLA40 | 609 | — |
| | | 1636HLA40 | 672 | — |
| | | | | |
| | | | | |

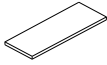
OPTIONS

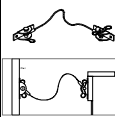



| | | | |
|--|--|--------------------------------|----------|
|  <p>Bow front option 1-1/2"</p> | | CX | 53 |
|  <p>Satin nickel lock, factory installed HL28 = 1 lock on right side door. HLA40 = 1 lock on right side door.</p> | | LKSNINS | 32 /ch. |
|  <p>Extra adjustable shelf, shelf supports included.</p> | 30"W hutch 36"W hutch | SH1428 SH1434 | 47 58 |
|  <p>Horizontal handle option. * Pricing upon request only. *</p> | | | |
|  <p>Anti-tipping kit mandatory for hutches. ** a minimum of 2 sets is necessary ** (sold separately)</p> | | DECR | 42 / ch. |

LF = Melamine top and frame
 LFL = Laminate top and melamine frame



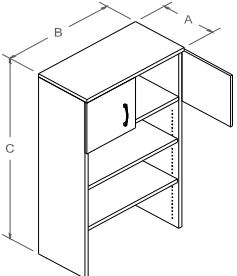
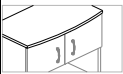

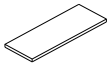

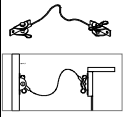
How to order?
 _ 1630HLA52
 (LF / LFL)

**CLOSED HUTCHES WITH
 HINGED DOORS**

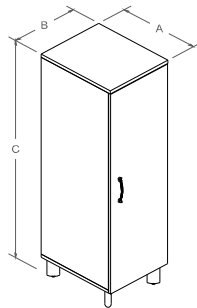
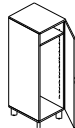
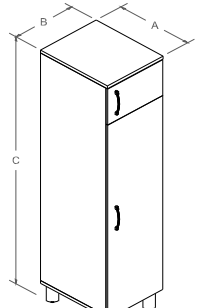
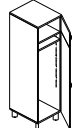
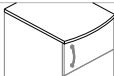
**** LFM = Linoleum top and melamine base (pricing upon request only).****
**** Pricing may vary depending on volume, please specify requested quantities ****

| | DESCRIPTION | PRODUCTS | FINISHES | |
|---|-------------|--|--------------------------------|----------------------|
| | | | melamine | laminate |
| | | | 1" LF | 1-1/16" LFL |
|  <p>HLA 52"H hutch with doors, including: - 2 hinged doors; - 2 satin nickel H130 handles for doors; - 13"H open space inside doors; - 2 adjustable shelves; - Rubber wire cover cap on bottom.</p> | | A B C | | |
| | | 1630HLA52 | 709 | — |
| | | 1636HLA52 | 782 | — |
| OPTIONS | | | | |
|  <p>Bow front option 1-1/2" (not available for HPOCLA hutch).</p> | | CX | 53 | |
|  <p>Satin nickel lock, factory installed HLA52 = 1 lock on right side door.</p> | | LKSNINS | 32 /ch. | |
|  <p>Extra adjustable shelf, shelf supports included.</p> | | 30"W hutch 36"W hutch | SH1428 SH1434 | 47 / ch. 58 / ch. |
|  <p>Horizontal handle option. * Pricing upon request only. *</p> | | | | |
|  <p>Anti-tipping kit mandatory for hutches. ** a minimum of 2 sets is necessary ** (sold separately)</p> | | DECR | 42 / ch. | |

**** LFM = Linoleum top and melamine base (pricing upon request only).****
**** Pricing may vary depending on volume, please specify requested quantities ****





| | DESCRIPTION | PRODUCTS | FINISHES | |
|--|--|--------------------------|----------|-------------|
| | | | melamine | laminata |
| | | | 1" LF | 1-1/16" LFL |
|  <p>"R" right side hinges "L" left side hinges</p> | <p>PEN1R PEN1L</p> <p>Wardrobe cabinet, including:</p> <ul style="list-style-type: none"> - 1 hinged door with satin nickel H160 handle; - Safety garment rail under adjustable shelf; - Ventilation grill - 4 satin nickel oval metal legs on levelers.  | A B C | | |
| | | 242072PEN1ROVAMSN | 935 | — |
| | | 242072PEN1LOVAMSN | 935 | — |
|  <p>"R" right side hinges "L" left side hinges</p> | <p>PEN2R PEN2L</p> <p>Wardrobe cabinet, including:</p> <ul style="list-style-type: none"> - 2 hinged doors with satin nickel H160 handles; - Safety garment rail under adjustable shelf; - Ventilation grill - 4 satin nickel oval metal legs on levelers.  | 242084PEN2ROVAMSN | 1055 | — |
| | | 242084PEN2LOVAMSN | 1055 | — |
| | | OPTIONS | | |
|  <p>Bow front option 1-1/2"</p> | | CX | 53 | |
|  <p>Satin nickel lock, factory installed PEN1 = 1 lock on door. PEN1 = 1 lock on top door, 1 lock on bottom door.</p> | | LKSNINS | 32 /ch. | |
|  <p>Extra adjustable shelf, shelf supports included.</p> | | SH2218 | 38 / ch. | |
|  <p>Wooden leg 3" x 3" x 6"H on leveler (all Logiflex color chart wood finishes).</p> | | WL3 | N/C | |
|  <p>Tubular metal leg 2-1/2" diam. x 6"H on leveler.</p> <p>** Please change leg codes for WL3 or IFMNSN.**</p> | | IFMNSN | N/C | |
|  <p>Horizontal handle option. * Pricing upon request only. *</p> | | | | |
|  <p>Anti-tipping kit mandatory for hutches. ** a minimum of 2 sets is necessary ** (sold separately)</p> | | DECR | 42 / ch. | |

LF = Melamine top and frame
 LFL = Laminate top and melamine frame

How to order?
 _ 243072PEN3OVAMSN
 (LF / LFL)

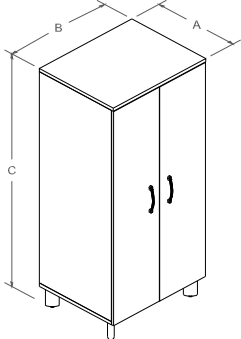
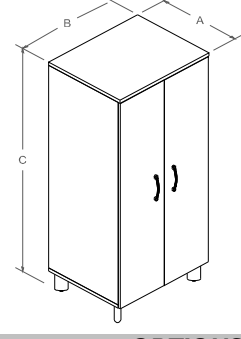
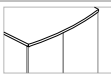
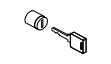
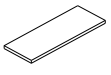
WARDROBE CABINETS

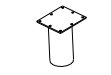
**** LFM = Linoleum top and melamine base (pricing upon request only).****
**** Pricing may vary depending on volume, please specify requested quantities ****

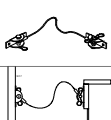





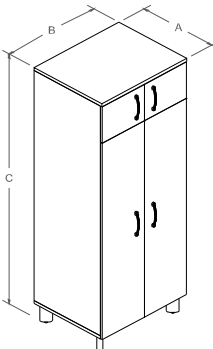
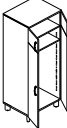
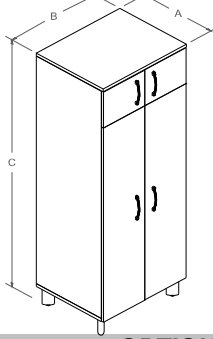
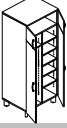
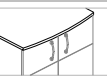

| | DESCRIPTION | PRODUCTS | FINISHES | |
|--|--|------------------|---------------|-------------|
| | | | melamine | laminate |
| | | | 1" LF | 1-1/16" LFL |
| A B C | | | | |
|  <p>PEN3 Wardrobe cabinet, including: - 2 hinged doors with satin nickel H160 handles; - Safety garment rail under adjustable shelf; - 2 ventilation grills - 4 satin nickel oval metal legs on levelers.</p> |  <p>PEN4 Wardrobe cabinet, including: - 2 hinged doors with satin nickel H160 handles; - Safety garment rail under adjustable shelf; - Central division; - 4 adjustable shelves; - 2 ventilation grills; - 4 satin nickel oval metal legs on levelers.</p> | 243072PEN3OVAMSN | 1370 | — |
| | | 243672PEN3OVAMSN | 1439 | — |
| | | 244272PEN3OVAMSN | 1507 | — |
| OPTIONS | | | | |
|  <p>Bow front option 1-1/2"</p> | | CX | | 53 |
|  <p>Satin nickel lock, factory installed PEN3 & PEN4 = 1 lock on right door (locking both doors).</p> | | LKSNINS | | 32 /ch. |
|  <p>Extra adjustable shelf, shelf supports included.</p> | | PEN3 | SH2228 | 27 / ch. |
| | | | SH2230 | 34 / ch. |
| | | | SH2240 | 40 / ch. |
| | | PEN4 | SH2213 | 59 / ch. |
| | | | SH2216 | 71 / ch. |
| | | | SH2219 | 83 / ch. |
|  <p>Wooden leg 3" x 3" x 6"H on leveler (all Logiflex color chart wood finishes).</p> | | WL3 | | N/C |
|  <p>Tubular metal leg 2-1/2" diam. x 6"H on leveler. ** Please change leg codes for WL3 or IFMNSN.**</p> | | IFMNSN | | N/C |
|  <p>Folding doors (allows easy access to people of reduced mobility). ** Available for 30"W and 36"W units only. **</p> | | FD | | 263 |
|  <p>Horizontal handle option. * Pricing upon request only. *</p> | | | | |
|  <p>Anti-tipping kit mandatory for hutches. ** a minimum of 2 sets is necessary ** (sold separately)</p> | | DECR | | 42 / ch. |

LF = Melamine top and frame
 LFL = Laminate top and melamine frame

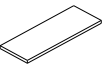
How to order?
 _ 243084PEN5OVAMSN
 (LF / LFL)

WARDROBE CABINETS

**** LFM = Linoleum top and melamine base (pricing upon request only).****
**** Pricing may vary depending on volume, please specify requested quantities ****

| | DESCRIPTION | PRODUCTS | FINISHES | |
|---|--|------------------|----------------|-------------|
| | | | melamine | laminate |
| | | | 1" LF | 1-1/16" LFL |
|  <p>PEN5 Wardrobe cabinet, including: - 4 hinged doors with satin nickel H160 handles; - Safety garment rail under adjustable shelf; - 2 ventilation grills; - 4 satin nickel oval metal legs on levelers.</p>  | | A B C | | |
| | | 243084PEN5OVAMSN | 1580 | — |
| | | 243684PEN5OVAMSN | 1649 | — |
| | | 244284PEN5OVAMSN | 1717 | — |
|  <p>PEN6 Wardrobe cabinet, including: - 4 hinged doors with satin nickel H160 handles; - Safety garment rail under adjustable shelf; - Central division; - 4 adjustable shelves; - 2 ventilation grills; - 4 satin nickel oval metal legs on levelers.</p>  | | 243084PEN6OVAMSN | 1785 | — |
| | | 243684PEN6OVAMSN | 1853 | — |
| | | 244284PEN6OVAMSN | 1922 | — |
| | | | | |
| OPTIONS | | | | |
|  | Bow front option 1-1/2" | | CX | 53 |
|  | Satin nickel lock, factory installed PEN5 & PEN6 = 1 lock on top right door (locking both top doors), 1 lock on bottom right door (locking both bottom doors). | | LKSNINS | 32 /ch. |
|  | Extra adjustable shelf, shelf supports included. | PEN5 | SH2228 | 27 / ch. |
| | | | SH2230 | 34 / ch. |
| | | | SH2240 | 40 / ch. |
| | | PEN6 | SH2213 | 59 / ch. |
| | | | SH2216 | 71 / ch. |
| | | | SH2219 | 83 / ch. |
|  | Wooden leg 3" x 3" x 6"H on leveler (all Logiflex color chart wood finishes). | | WL3 | N/C |
|  | Tubular metal leg 2-1/2" diam. x 6"H on leveler. ** Please change leg codes for WL3 or IFMNSN.** | | IFMNSN | N/C |
|  | Folding doors (allows easy access to people of reduced mobility). ** Available for 30"W and 36"W units only. ** | | FD | 263 |
|  | Horizontal handle option. * Pricing upon request only. * | | | |
|  | Anti-tipping kit mandatory for hutches. ** a minimum of 2 sets is necessary ** (sold separately) | | DECR | 42 / ch. |





LF = Melamine top and frame
 LFL = Laminate top and melamine frame

How to order?
 _ 244272PEN7ROVAMSN
 (LF / LFL)

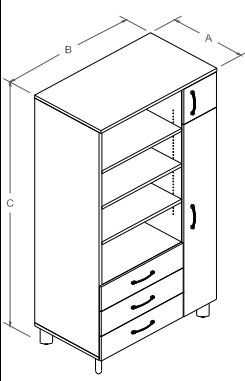
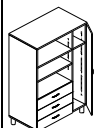
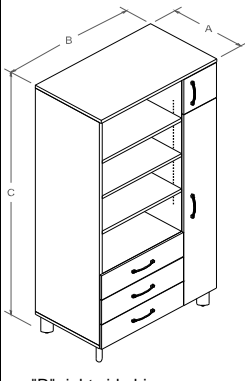
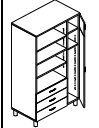
WARDROBE CABINETS

**** LFM = Linoleum top and melamine base (pricing upon request only).****
**** Pricing may vary depending on volume, please specify requested quantities ****

| | DESCRIPTION | PRODUCTS | FINISHES | | | |
|--|--|---|--|---|---|-------------------------------------|
| | | | melamine | laminat | | |
| | | | 1" LF | 1-1/16" LFL | | |
|  <p>"R" right side hinges "L" left side hinges</p> | <p>PEN7R PEN7L</p> <p>Wardrobe cabinet, including:</p> <ul style="list-style-type: none"> - 1 hinged door with satin nickel H160 handle; - Safety garment rail under adjustable shelf; - 2 ventilation grills; - Open space with 3 adjustable shelves; - 3 drawers with full extension Quadro slides and Interlock system with satin nickel H160 handles; - 4 satin nickel oval metal legs on levelers.  | <p>A B C</p> <p>244272PEN7ROVAMSN</p> <p>244272PEN7LOVAMSN</p> <p>244872PEN7ROVAMSN</p> <p>244872PEN7LOVAMSN</p> | <p>2363</p> <p>2363</p> <p>2431</p> <p>2431</p> | <p>—</p> <p>—</p> <p>—</p> <p>—</p> | | |
| | |  <p>"R" right side hinges "L" left side hinges</p> | <p>PEN8R PEN8L</p> <p>Wardrobe cabinet, including:</p> <ul style="list-style-type: none"> - 2 hinged doors with satin nickel H160 handles; - Safety garment rail under adjustable shelf; - 2 ventilation grills; - Open space with 3 adjustable shelves; - 3 drawers with full extension Quadro slides and Interlock system with satin nickel H160 handles; - 4 satin nickel oval metal legs on levelers.  | <p>244284PEN8ROVAMSN</p> <p>244284PEN8LOVAMSN</p> <p>244884PEN8ROVAMSN</p> <p>244884PEN8LOVAMSN</p> | <p>2573</p> <p>2573</p> <p>2641</p> <p>2641</p> | <p>—</p> <p>—</p> <p>—</p> <p>—</p> |

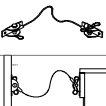
| OPTIONS | | | |
|---|--|----------------|----------|
|  | Bow front option 1-1/2" | CX | 53 |
|  | Satin nickel lock, factory installed PEN7 = 1 lock on wardrobe's door, PEN8 = 1 lock on wardrobe's top door, 1 lock on wardrobe's bottom door. | LKSNINS | 32 / ch. |
|  | Wooden leg 3" x 3" x 6"H on leveler (all Logiflex color chart wood finishes). | WL3 | N/C |
|  | Tubular metal leg 2-1/2" diam. x 6"H on leveler. ** Please change leg codes for WL3 or IFMNSN.** | IFMNSN | N/C |
|  | Horizontal handle option. * Pricing upon request only. * | | |
|  | Anti-tipping kit mandatory for hutches. ** a minimum of 2 sets is necessary ** (sold separately) | DECR | 42 / ch. |

LF = Melamine top and frame
 LFL = Laminate top and melamine frame

How to order?
 _ 3922TLRT
 (LF/LFL)

HEADBOARDS & FOOTBOARDS

**** LFM = Linoleum top and melamine base (pricing upon request only). ****
**** Pricing may vary depending on volume, please specify requested quantities ****

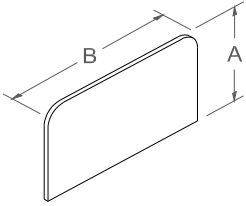
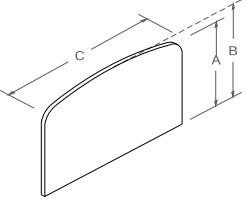
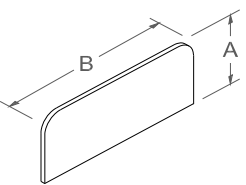
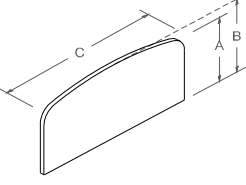
| | DESCRIPTION | PRODUCTS | FINISHES | |
|---|-------------|-------------------|----------|----------------|
| | | | melamine | laminata |
| | | | 1" LF | 1-1/16" LFL |
|  <p>TLRT Rectangular headboard, 39"W x 22"H.</p> | | B C | | |
| | | 3922TLRT | 95 | — |
|  <p>TLCX Curved headboard, 39"W x 25"H.</p> | | A B C | | |
| | | 222539TLCX | 110 | — |
|  <p>PLRT Rectangular footboard, 39"W x 16"H.</p> | | B C | | |
| | | 3916PLRT | 79 | — |
|  <p>PLCX Curved footboard, 39"W x 19"H.</p> | | A B C | | |
| | | 192139PLCX | 84 | — |

LF = Melamine top and frame
 LFL = Laminate top and melamine frame

How to order?
 _ 203024MTV1OVAMSN
 (LF / LFL)

AUDIO-VISUAL UNITS

**** LFM = Linoleum top and melamine base (pricing upon request only).****
**** Pricing may vary depending on volume, please specify requested quantities ****

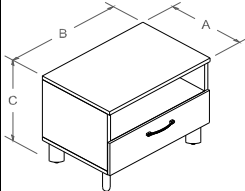
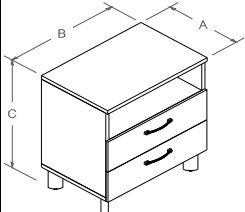
| | DESCRIPTION | PRODUCTS | FINISHES | |
|---|-------------|------------------|----------|----------------|
| | | | melamine | laminata |
| | | | 1" LF | 1-1/16" LFL |
|  <p>MTV1 Audio-visual unit, including: - 8"H open space on top of drawer with 1-1/2" diam. Grommet on back; - 1 drawer with full extension slides; - 1 satin nickel H160 handle on drawer; - 4 satin nickel oval metal legs on levelers.</p> | | A B C | | |
| | | 203024MTV1OVAMSN | 467 | 509 |
| | | 203624MTV1OVAMSN | 515 | 567 |
| | | 243024MTV1OVAMSN | 515 | 567 |
| | | 243624MTV1OVAMSN | 562 | 625 |
| | | | | |
|  <p>MTV2 Audio-visual unit, including: - 8"H open space on top of drawer with 1-1/2" diam. Grommet on back; - 2 drawers with full extension slides; - 2 satin nickel H160 handles on drawers; - 4 satin nickel oval metal legs on levelers.</p> | | 203032MTV2OVAMSN | 572 | 614 |
| | | 203632MTV2OVAMSN | 620 | 672 |
| | | 243032MTV2OVAMSN | 620 | 672 |
| | | 243632MTV2OVAMSN | 667 | 730 |
| | | | | |
| | | | | |

OPTIONS

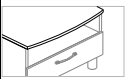

Bow front option 1-1/2"

CX 53



Wooden leg 3" x 3" x 6"H on leveler (all Logiflex color chart wood finishes).

WL3 N/C



Tubular metal leg 2-1/2" diam. x 6"H on leveler.



IFMNSN N/C

**** Please change leg codes for WL3 or IFMNSN.****

LF = Melamine top and frame
 LFL = Laminate top and melamine frame



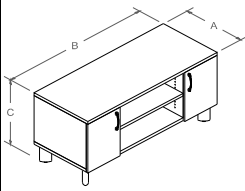
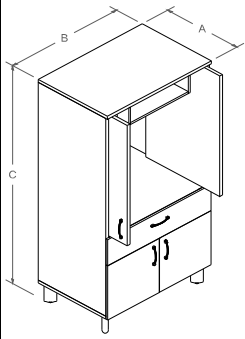
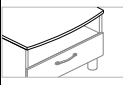

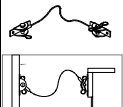

How to order?
 _ 204824MTV3OVAMSN
 (LF / LFL)

AUDIO-VISUAL UNITS

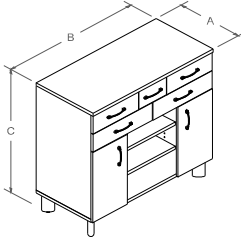
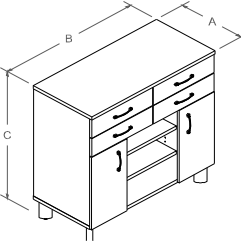
| | | ** LFM = Linoleum top and melamine base (pricing upon request only).** | | | |
|---|---|--|----------------------|---------------------------|-----|
| | | ** Pricing may vary depending on volume, please specify requested quantities ** | | | |
| | DESCRIPTION | PRODUCTS | FINISHES | | |
| | | | melamine 1" LF | laminat 1-1/16" LFL | |
|  | MTV3 Audio-visual unit, including: - 2 hinged doors on each side with 16"H interior free space; - 16"H open space with adjustable shelf; - 2 satin nickel H160 handles on doors; - 4 satin nickel oval metal legs on levelers and 1 central support leg. | A B C | | | |
| | | 20" profond | 204824MTV3OVAMSN | 609 | 683 |
| | | 24" profond | 244824MTV3OVAMSN | 656 | 788 |
| | | | | | |
|  | MTV4 Audio-visual unit, including: - 2 retractable doors on top; - 1 fixed shelf for video/DVD; - 1 drawer with full extension slides for storage; - 2 hinged doors on bottom; - 5 satin nickel H160 handles on drawer and doors; - 4 satin nickel oval metal legs on levelers. | 24" profond | 243672MTV4OVAMSN | 1045 | — |
| | | | 244272MTV4OVAMSN | 1092 | — |
| | | 30" profond | 303672MTV4OVAMSN | 1092 | — |
| | | | 304272MTV4OVAMSN | 1139 | — |
| OPTIONS | | | | | |
|  | Bow front option 1-1/2" | | CX | 53 | |
|  | Wooden leg 3" x 3" x 6"H on leveler (all Logiflex color chart wood finishes). | | WL3 | N/C | |
|  | Tubular metal leg 2-1/2" diam. x 6"H on leveler. | | IFMNSN | N/C | |
| | ** Please change leg codes for WL3 or IFMNSN.** | | | | |
|  | Anti-tipping kit mandatory for hutches. ** a minimum of 2 sets is necessary ** (sold separately) | | DECR | 42 / ch. | |

LF = Melamine top and frame
 LFL = Laminate top and melamine frame

How to order?
 _ 204242MF1OVAMSN
 (LF / LFL)

| ** LFM = Linoleum top and melamine base (pricing upon request only).** | | | | |
|--|--|-----------------|----------------------|---------------------------|
| ** Pricing may vary depending on volume, please specify requested quantities ** | | | | |
| | DESCRIPTION | PRODUCTS | FINISHES | |
| | | | melamine 1" LF | laminat 1-1/16" LFL |
|  | MF1 Activity unit, including: - 5 drawers with full extension slides; - 2 hinged doors on each side; - Central open space with 2 adjustable shelves; - 7 satin nickel H160 handles on drawers and doors; - 4 satin nickel oval metal legs on levelers and 1 central support leg. | A B C | | |
| | | 204242MF1OVAMSN | 1958 | 2021 |
|  | MF2 Activity unit, including: - 4 drawers with full extension slides; - 2 hinged doors on each side; - Central open space with 2 adjustable shelves; - 6 satin nickel H160 handles on drawers and doors; - 4 satin nickel oval metal legs on levelers and 1 central support leg. | 204242MF2OVAMSN | 2090 | 2153 |
| | | OPTIONS | | |
|  | Bow front option 1-1/2" | CX | 53 | |
|  | Wooden leg 3" x 3" x 6"H on leveler (all Logiflex color chart wood finishes). | WL3 | N/C | |
|  | Tubular metal leg 2-1/2" diam. x 6"H on leveler. | IFMNSN | N/C | |
| ** Please change leg codes for WL3 or IFMNSN.** | | | | |
|  | Anti-tipping kit mandatory for hutches. ** a minimum of 2 sets is necessary ** (sold separately) | DECR | 42 / ch. | |
|  <p style="text-align: center;">* Logiflex is not liable for any breakage * if this directive is not followed.</p> | | | | |

**** LFM = Linoleum top and melamine base (pricing upon request only).****
**** Pricing may vary depending on volume, please specify requested quantities ****

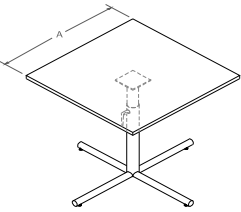
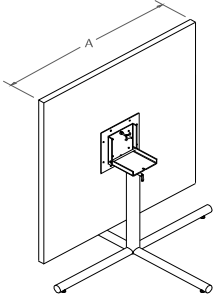
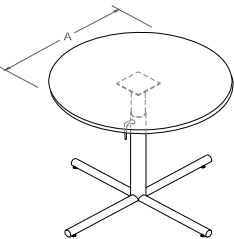
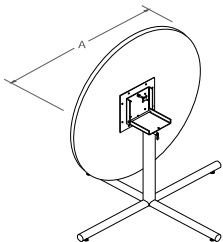
| | <i>DESCRIPTION</i> | <i>PRODUCTS</i> | <i>FINISHES</i> | |
|---|---|---|-------------------------|-------------------------|
| | | | <small>melamine</small> | <small>laminata</small> |
| | | | 1" LF | 1-1/16" LFL |
|  | <p>TC Square table with :</p> <ul style="list-style-type: none"> - Satin nickel x-shaped profiled steel base (3" diam. post). - Base adjustable in height, from 28" to 36" H. - Pneumatic mechanism; - 4 adjustable levelers. | A | | |
|  | | <p>38TCPBX38SN</p> <p>42TCPBX38SN</p> | 1181 | 1286 |
| | | <p>38TCBPFTX38SN</p> <p>42TCBPFTX38SN</p> | 1213 | 1344 |
| | | | | |
|  | <p>TR Round table with :</p> <ul style="list-style-type: none"> - Satin nickel x-shaped profiled steel base (3" diam. post). - Base adjustable in height, from 28" to 36" H. - Pneumatic mechanism; - 4 adjustable levelers. | | | |
|  | | <p>38TRBPX38SN</p> <p>42TRBPX38SN</p> | 1234 | 1339 |
| | | <p>38TRBPFTX38SN</p> <p>42TRBPFTX38SN</p> | 1265 | 1397 |
| | | | | |

LF = Melamine top and frame
 LFL = Laminate top and melamine frame

How to order?
 _ 38ARC9BPX38SN
 (LF / LFL)

ARC TABLES

**** LFM = Linoleum top and melamine base (pricing upon request only). ****
**** Pricing may vary depending on volume, please specify requested quantities ****

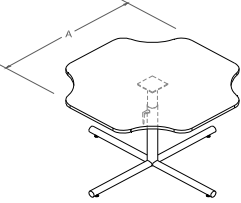
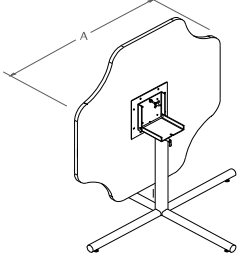
| | DESCRIPTION | PRODUCTS | FINISHES | |
|---|--|-------------------------|----------|----------------|
| | | | melamine | laminat |
| | | | 1" LF | 1-1/16" LFL |
|  <p>ARC Square table with curved notched corners and: - Satin nickel x-shaped profiled steel base (3" diam. post). - Base adjustable in height, from 28" to 36" H. - Pneumatic mechanism; - 4 adjustable levelers.</p> |  <p>ARC-FT Square table with curved notched corners and: - Satin nickel x-shaped profiled steel base (3" diam. post). - Base adjustable in height, from 28" to 36" H. - Pneumatic mechanism; - Folding table mechanism; - 4 adjustable levelers.</p> | A | | |
| | | 38ARC9BPX38SN | 1286 | 1391 |
| | | 42ARC10BPX38SN | 1318 | 1449 |
| | | 38ARC9BPFTX38SN | 1381 | 1486 |
| | | 42ARC10BPFTX38SN | 1412 | 1544 |
| | | | | |

logiflex

FACTORY

1235 SAINT-ROCH ROAD NORTH
SHERBROOKE, QUEBEC
CANADA J1N 0H2

 **1(877) 864-9323**

 **1(800) 474-7830**

WWW.LOGIFLEXONLINE.COM



PRINTED IN CANADA